

Assembly & Instruction Manual Bayou Jumper 40 Meter CW Transceiver

For revC (Red Panel) kits shipped after 19 July 2021
Copyright 2017, 2020, 2021

David Cripe NMØS
Jim Giammanco N5IB
&
Four State QRP Group



NØSM photo

PLEASE READ THIS ENTIRE MANUAL BEFORE BEGINNING ASSEMBLY

Introduction

Thank you for purchasing a Bayou Jumper transceiver kit. We hope you will enjoy building it and have many QSOs with it. This kit is comprised of high-quality components, a silkscreened, solder-masked, double-sided PC board and front panel, and hardware for mounting in a wooden enclosure.

This kit owes its genesis to the imagination of Jim Giammanco, **N5IB**, who envisioned this project in homage to the classic 'Paraset' transceiver, <http://www.paraset.nl/> the legendary spy radio from World War II. Using the same circuit architecture as the original, Jim brought it up to date with solid-state circuitry, giving the user an authentic feel of the original radio without the high voltages and scarce components of a tube circuit.

Jim named his creation the *Bayou Jumper* after the popular KnightKit *Ocean Hopper* regenerative receiver that so many novice hams built a half-century ago, and with a salute to his Louisiana heritage. His presentation on the project was one of the most popular presentations at OzarkCon 2016. The Four-State QRP Group is proud to be able to present the Bayou Jumper to the QRP community.

The transceiver is comprised of two separate circuits, a crystal-controlled transmitter and a regenerative receiver. The transmitter uses 4SQRP's super simple, super robust NS-40 transmitter circuit, with trademark on-board spiral PCB trace inductors, and between 4 and 5 watts output power.

The Bayou Jumper utilizes a regenerative receiver, the same as the original Paraset. No other receiver circuit provides the combination of sensitivity and selectivity with low parts count. Regenerative receivers were popular among hams for this reason. The receiver in the Bayou Jumper has been measured to have a Minimum Discernible Signal (MDS) of better than -120 dBm, which is as good as many commercial receivers. In the Bayou Jumper, the receiver tunes independently from the transmitter frequency, so there is a 'Spotting' function to allow the user to tune the receiver to the transmitter frequency.

Switching between transmit and receive is performed with a rotary switch, just as was done with the original Paraset. You cannot get more simple and reliable than that!

The entire transceiver was designed to fit inside a standard wooden box, available from Hobby Lobby. It can be ordered here:

<http://www.hobbylobby.com/Crafts-Hobbies/Wood-Crafting/Unfinished-Wood/Wood-Rectangle-Box-Set-with-Silver-Handle/p/25426-GA0369>

The on-line sale is for a set of three boxes, of which the smallest is used. The boxes can be purchased individually in stores, **SKU# 662536S**.

Theory of Operation

The Bayou Jumper, like the Paraset that inspired its creation, utilizes very simple and robust circuitry to achieve reliable operation. Despite this simplicity, it attains the maximum of performance from its minimum number of components, in the true spirit of QRP.

The transmitter design of the Bayou Jumper is borrowed from the 4SQRP classic 'NS-40'. This design is a master-oscillator/power amplifier circuit, with high-efficiency spiral PCB coils serving as the transmitter's harmonic filter. The 2N7000 Master Oscillator, Q5, works against the gate capacitance of the IRF510 power amplifier, Q4, as an unusual inverted Colpitts oscillator. The power amplifier Q4 is tuned to operate in the Class E mode, generating 5 watts from 13.6 volts, at better than 85% efficiency. Closing the key contact grounds the source circuits of Q4 and Q5 permitting oscillation to commence. If the transmit/receive switch is in the receive position, closing the key permits the Master Oscillator to oscillate without the PA operating, enabling spotting of the oscillator frequency in the receiver.

A built-in key is included in the design – just like in the original Paraset!

Because the entire PA current passes through the final amplifiers's keying circuit, the revC kit now includes a PNP high current keying transistor, as is described in **Appendix K**. This allows the revC Bayou Jumper to be used with almost any electronic keyer without worry about the current handling capacity of the keyer's output stage.

The receiver is a simple regenerative circuit, based on the innovative designs of Charles Kitchin, N1TEV. Q2, a J-310 JFET, is a regenerative detector in an Armstrong circuit, with a 1N5819 diode acting as a varactor capacitor in the tickler throttle circuit. The regeneration control, potentiometer R10, varies the reverse bias voltage on the diode D2, changing its capacitance and varying the amount of feedback current it passes through the tickler feedback winding of L1.

The receiver frequency is tuned by also using a reverse biased diode as a varactor. The inductor L1 resonates against the sum capacitance of C20, (optionally C20a) C30, and diode D3. Tuning is performed by potentiometer R8, which varies the reverse bias voltage on D3, thus varying its capacitance.

The antenna is coupled to the detector through the grounded-base amplifier Q1, a 2N3904. This amplifier also isolates detector oscillations, preventing them from being radiated back through the antenna. An RF attenuator control, R1, can be used to reduce the amplitude of strong signals that might overload the receiver.

The detected audio appears at the source of the regenerative detector Q2, and is coupled through capacitor C5 to audio preamplifier Q3, a 2N3904. Its output is coupled to the volume control R6.

The output of the volume pot is amplified by the Audio Amplifier U1. This IC, an NJM2113 is a low-noise headphone driver amplifier. Its balanced output feeds the tip and ring contacts of the Headphone jack, J4. The shell contact is left floating, placing the two headphone elements in series. This amplifier is also capable of driving an external 8 ohm speaker.

A 6-volt regulator IC, U2, provides steady bias voltage to the low-level RF and audio circuitry of the receiver, eliminating any tendency toward audio howl or instability.

Switching between transmit and receive operation is performed with a rotary switch SW1. This disables the receiver during transmit, and switches the antenna between the transmitter and receiver sections. This switch also has an OFF position, switching the antenna input to ground as well.

First Steps

Before getting started with building the kit, take some time to organize and familiarize yourself with the parts provided and check them against the Bill of Materials (pages 34 & 35). Building over a cookie sheet is recommended to minimize the chance of lost parts. If parts are missing in your kit, send an email to the kitter listed at ***4SQRP.com***. He will promptly provide replacements.

Schematics are provided separately as image files in the documentation package, as well as being incorporated into this manual. It is highly recommended that you print a couple of copies at 11 X 17 inch format at your local UPS Store, Staples, etc. As you build, use a highlighter to mark off parts that have been soldered onto the PCB on one copy. When you think you are done, you can check that copy to verify that all of the parts have been installed.

It is helpful to acquire the necessary tools and supplies before beginning. These include:

- *Soldering iron – ESD safe, 20-30W, preferably thermostatically controlled.
- *Small diameter (0.025” recommended) 60/40 or 63/37 rosin core solder
- *Wire stripper
- *X-Acto type hobby knife (#11 blade best)
- *Diagonal cutters (flush-cutting type preferred)
- *Needle-nose pliers
- *Fine file or emery board
- *Phillips screwdriver
- *Allen wrench: 1.5mm – for the pointer knob’s set screw
- *Hand drill with 1/8” bit
- *Non-metallic alignment tool
- *Fine jeweler’s screwdrivers
- *Electrical tape
- *Clear fingernail polish
- *Wood glue
- *Clamps or spring clothespins
- *Magnifier
- *Digital volt-ohm-meter
- *Calibrated general coverage receiver, 40M CW receiver, or frequency counter

Soldering is not hard if the proper procedure is followed. The soldering iron is to be used to heat up the PC pad and component lead, and the solder applied to the pad, where it melts and flows into the hole. Do not melt the solder onto the tip of the iron and then attempt to dab it onto the joint – a defective connection will result! After soldering, check the top (component side) of the board, to be sure the solder has filled the hole completely, and wicked up around the component lead. Re-heat and apply more solder if necessary.

Enclosure

It would be best to prepare the enclosure before beginning assembly of the PC boards, in case any minor sanding or filing were to be needed to refine the fit of the boards into the box. Do a “dry fit” to verify that the four wood posts are the proper length to allow the panel to be recessed slightly. There has been some variation in dimensions of the boxes, occasionally requiring some trimming.

The enclosure must be prepared to mount the circuit boards. Included in the kit are four 3/8” wooden blocks that must be glued into the four inside corners of the box. Use wood glue to attach them (Elmer’s Carpenter’s Wood Glue – the yellow kind). They should be spaced down from the rim of the box by the thickness of two PC boards (about 1/8”) – use the two crystal adapter boards as a thickness gauge.

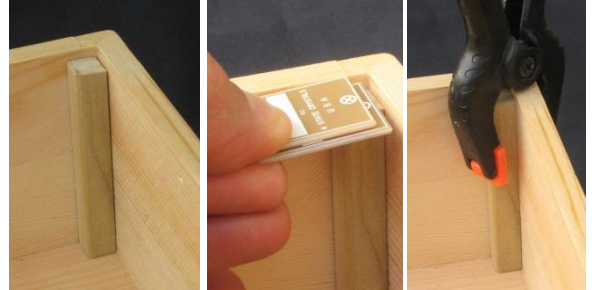

After the glue has dried for several hours, place the top panel circuit board onto the four corner blocks. Use a pencil to mark through the four corner holes in the top panel board onto the corner blocks. Remove the top panel.

There are four wood screws in the parts kit for mounting the circuit board assembly. If driven directly into the corner blocks, there is a risk the blocks will split, so it is necessary to drill pilot holes for the mounting screws. Use a 1/8” bit in a hand drill (or drill press if available), drill down approximately 1/2”.

Solder Filling Selected Vias

*Vias are small plated-through holes that electrically join the top and bottom copper layers of the circuit board. Looking closely at the heavy traces near D1 and C22 you’ll see two groups of four vias in the middle of those traces. These traces, and vias, carry the full transmitter current – several hundred mA. To ensure a low resistance path these eight vias should be **filled**, that is, enough solder should be flowed into them that the solder is level with the via pads on both the top and bottom sides. The same should be done to the vias at the center of each of the etched inductors.*



Fill the four vias in the heavy trace near D1

Fill the four vias in the heavy trace near C22

Fill the three vias in the centers of the three etched inductors L3, L5, and L6

Preliminary Assembly

The large components (four potentiometers, BNC jack, and rotary switch) will be installed first. In order to ensure that these components properly line up with the holes in the front panel, test fittings will be performed.

Locate the six 5/8" hex standoffs and twelve of the 6-32 x 3/8" machine screws. Use six of the screws to install standoffs on the bottom side of the **Front Panel** circuit board (**NOT** the main circuit board) at the six perimeter mounting holes (**NOT** the four corner holes).

The first components to be installed on the **MAIN** circuit board will be the four potentiometers. R6, R8 and R10 are 50 k pots, marked "503" while R1 is a 5 k pot, marked "502." All four of these potentiometers will be installed "standing proud" to ensure that there is enough shaft above the panel to accept the knobs securely.

*Note: A few builders have expressed a preference for having the main tuning dial indexed at the bottom, rather than at the top, of the dial. To accommodate this request there are two groups of pads provided for R8, the main tuning control. The group nearest jumper JP1 (indicated by the arrow in the photo below) is normally used. However, if you wish to make use of the small index mark at the bottom of the tuning dial, use the alternate set of pads so that the span of the pot will match that index mark. See **Appendix M** for details about required wire jumpers.*

Place the main PC board flat, right side up, on a hard work surface, and insert the mounting tabs and pins of R8 (50 k, marked "503") through the PCB mounting holes so that the tips of the two tabs rest flush against the work surface without extending past the bottom of the board. This ensures that the shaft of the pot sits as high as possible.



Notice that when the two mounting tabs are flush with the bottom of the board, the three contact pins will not quite penetrate all the way to the bottom. This is normal and correct. The holes are through-plated, and when soldered the connections will be solid.

Make sure the pot shaft is vertical, and then solder only one of the mounting tabs to the board. It will be easiest to solder on the top side of the board.

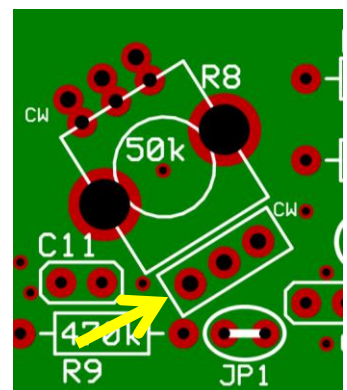

Place the front panel, with its standoffs in position, atop the main PCB. Use three screws to temporarily secure the panel to the main board. Inspect the alignment of R8 and make sure that the shaft can turn easily without rubbing the sides of the hole. If needed, reheat the soldered tab and reposition the part.

Remove the front panel and set it aside for the moment. Do not yet solder the remaining tab and pins.

Repeat the above two steps for the other two 50 k pots, R10 and R6 (marked “B5 03”), and the 5 k pot, R1 (marked “B5 02”). Again, solder only one tab of each part at this time. Check the alignment of each one by temporarily replacing the front panel each time.

When all four potentiometers have been partially installed, replace the front panel. Secure it with all six screws, and make a final check of the alignment. When you are satisfied with the positioning, remove the front panel and solder the remaining tab as well as the three pins of each part.

Next the rotary switch and the BNC jack will be installed. Alignment of these parts will be much more straightforward, since they will be firmly seated against the PCB and should “auto align.”

*You may wish to read the section in **Appendix A** concerning shortening the shaft of the rotary switch. It's only for appearance sake, to allow the knob to nestle down close to the panel. If you decide to do this optional step, it is most easily accomplished before the switch is soldered to the board.*

(optional) The shaft of the rotary switch is too long to allow the selector knob to mount close enough to the panel. Trim a bit off, but be sure that there is least $\frac{1}{4}$ " of the shaft remaining.

The plastic index post is not needed and will interfere with the front panel mounting. Nip it off with diagonal cutters.

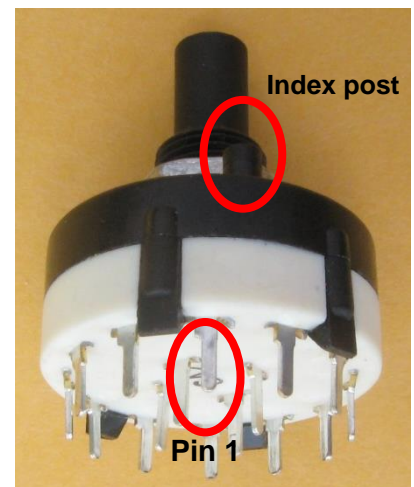

Install the rotary switch SW1. Be sure the nut on the bushing is snugged up against the toothed lock washer. Do not over tighten. Be certain that Pin 1 is inserted into the square pad marked “1”. The pin numbers are molded into the switch body. Make sure the switch is fully seated against the PCB and the shaft is vertical. Solder only one of the four inside pins at this time.

Install the BNC jack in its location at the upper left corner of the PCB. Be sure it is flat and flush against the board and is vertical. Solder only the center pin at this time.

Re-install the front panel and make another alignment check. Locate the “chicken head” pointer knob and install it on the rotary switch’s shaft. You’ll need a 1.5 mm Allen wrench to tighten the set screw. Check that the pointer will align with the panel markings for the three switch positions. If all is satisfactory, remove the knob and panel and set them aside. You may leave the standoffs in position if you wish.

Now solder all of the remaining pins of the BNC jack and rotary switch.

The leads of resistors and axial leaded inductors should be bent in a gentle radius about 0.1” from the body of the part, so that the component body is not stressed or broken. If you have a bending jig, use it, selecting 0.4” spacing for all ¼ W resistors and diodes, 0.5” for L4, and 0.6” for L2. The bodies of these components should rest flush against the board surface when mounted.

Inductors

There are two molded inductors that look a lot like resistors. Add these next. Be especially careful when bending the leads of these parts. Notice the relative sizes in the photo. The one with the larger inductance (L4 470µH) is the smaller physical size and may have either a brown or green body.



L4: 470 µH

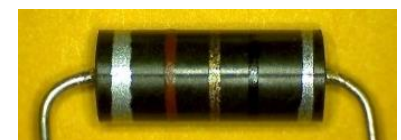

L2: 1 µH

√	Ref	Value	Marking	Description
	L2	1.0 µH	Wide Silver-Brown-Gold-Black-Silver	Molded Axial Choke .6” LS
	L4	470 µH	Wide Silver-Yellow-Violet-Brown-Silver	Molded Axial Choke .5” LS

*Special note for builders who intend to install a NAIMH Soup'er Up'er accessory board that is described in **Appendix J**.*

You may wish to just tack solder R9 and C9 to the board in the upcoming steps, leaving extra long lead lengths, since these parts will be subsequently removed after the basic checkout of the Bayou Jumper, prior to installation of the Soup'er Up'er. Leave enough lead that they can be easily nipped off and salvaged for the spare parts bin.

Resistors

Next, install these resistors, whose lead spacings may all be prepared as 0.4".

Save a few of the discarded leads for use as test points and jumpers later on.

√	Ref	Value	Marking	Description
	R16	100 Ω	Brown-black-brown	¼ W 5% axial
	R17	1.0 k	Brown-black-red	¼ W 5% axial
	R2	1.0 M	Brown-black-green	¼ W 5% axial
	R4	1.0 M	Brown-black-green	¼ W 5% axial
	R15	100 k	Brown-black-yellow	¼ W 5% axial
	R3	2.7 k	Red-violet-red	¼ W 5% axial
	R12	3.3 k	Orange-orange-red	1/4 W or 1/8 W, 5% axial
	R7	3.3 k	Orange-orange-red	1/4 W or 1/8 W, 5% axial
	R13	330 k	Orange-orange-yellow	¼ W 5% axial
	R5	33 k	Orange-orange-orange	¼ W 5% axial
	R11	470 k	Yellow-violet-yellow	¼ W 5% axial
	R9	470 k	Yellow-violet-yellow	¼ W 5% axial
	R14	470 k	Yellow-violet-yellow	¼ W 5% axial
	R18	470 k	Yellow-violet-yellow	¼ W 5% axial
	R21	Zero ohms	Wire jumper	Not used, replace with jumper wire

Note: Some builders have found that installing C18 and D3, (and if needed, C31) on the bottom side of the circuit board helps to reduce thermal drift. To facilitate that choice, the locations of those components are marked both on the top and the on the bottom sides with silk-screened labels.

Semiconductors

Identify and install the following diodes and transistors. Be certain that their polarity is correct, and that they match the board's silkscreened outlines.

It is not necessary to secure Q4 and Q6 to the PCB, but you may safely do so if you wish (*4-40 machine screw & nut - hardware not supplied with kit*).

A 4-40 x 1/2" screw and nut are supplied and should be used to secure Q7.

No insulating film is required beneath these parts.

Note: The band on the silk screen outline for D1 may be partially obscured by several vias. The banded end of D1 should be oriented towards L6. You may wish to elevate the body of D1 very slightly above the board so that it is clear of those solder-filled vias.

√	Ref	Value	Description
	D1	1N5819	Schottky Diode (rectifier)
	D2	1N5819	Schottky Diode (varactor)
	D3	1N5819	Schottky Diode (varactor)
	Q1	2N3904	TO-92 NPN BJT rf amp
	Q3	2N3904	TO-92 NPN BJT af amp
	Q5	2N7000 <i>Static sensitive part *</i>	TO-92 N-Channel Enhancement Mode MOSFET (oscillator)
	Q4	IRF510 <i>Static sensitive part *</i>	TO-220 N-Channel Enhancement Mode Power MOSFET (PA)
	Q6	IRF510 <i>Static sensitive part *</i>	TO-220 N-Channel Enhancement Mode Power MOSFET
	Q7	TIP-42 Use #4-40 x 1/2" screw and nut	TO-220 PNP BJT
	Q2	J-310	TO-92 N-Channel JFET (regen detector)
	U1	NJM2113	DIP-8 Audio Amp Use supplied socket
	U2	78L06	TO-92 6 Volt Positive Regulator

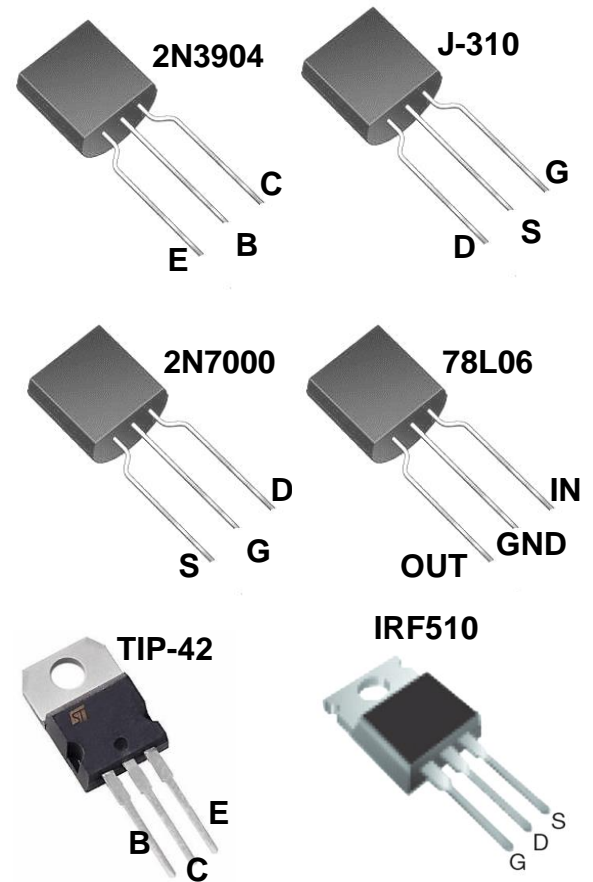

* Touch a grounded object before handling static sensitive parts. Be sure your soldering tools are grounded or are rated ESD safe

Capacitors

The ceramic monolithic capacitors used throughout the kit are small and their markings not always easy to read. Use a magnifier to verify the values. Depending on part sources, the bodies may be blue or tan colored, but the most likely color is indicated. **MAKE SURE THAT THE 120 pF CAP GOES IN C20.**

Electrolytic capacitors must be installed with the correct polarity. The cases are marked to indicate the negative lead, which goes into the round pad on the board. The longer lead is positive, and goes into the square pad. Install these capacitors, solder and trim the leads. Check off each part as you install it.

Do not install C31 or C20a at this time.

√	Ref	Value	Marking	Type
	C8	0.001 μ F	102	Dipped Monolithic Ceramic NP0, blue body, 0.2" lead spacing
	C14	0.001 μ F	102	Dipped Monolithic Ceramic NP0, blue body, 0.2" lead spacing
	C15	0.001 μ F	102	Dipped Monolithic Ceramic NP0, blue body, 0.2" lead spacing
	C28	0.0033 μ F	332	Dipped Monolithic Ceramic NP0, blue body, 0.1" lead spacing
	C1	0.01 μ F	103	Ceramic Disk, red body, 0.1" lead spacing
	C2	0.01 μ F	103	Ceramic Disk, red body, 0.1" lead spacing
	C11	0.01 μ F	103	Ceramic Disk, red body, 0.1" lead spacing
	C17	0.01 μ F	103	Ceramic Disk, red body, 0.1" lead spacing
	C24	0.033 μ F	333	Dipped Monolithic Ceramic, tan body, 0.2" lead spacing
	C5	0.1 μ F	104	Dipped Monolithic Ceramic, tan body, 0.1" lead spacing
	C7	0.1 μ F	104	Dipped Monolithic Ceramic, tan body, 0.1" lead spacing
	C19	0.1 μ F	104	Dipped Monolithic Ceramic, tan body, 0.1" lead spacing
	C25	0.1 μ F	104	Dipped Monolithic Ceramic, tan body, 0.1" lead spacing
	C27	0.1 μ F	104	Dipped Monolithic Ceramic, tan body, 0.1" lead spacing
	C29	0.1 μ F	104	Dipped Monolithic Ceramic, tan body, 0.1" lead spacing
	C32	0.1 μ F	104	Dipped Monolithic Ceramic, tan body, 0.1" lead spacing
	C34	0.22 μ F	224	Dipped Monolithic Ceramic, brown body, 0.2" lead spacing
	C10	1.0 μ F	1 uF	Aluminum Electrolytic, 0.1" lead spacing, observe polarity, longer lead is +
	C4	100 pF	101	Dipped Monolithic Ceramic NP0, blue or tan body, 0.1" lead spacing
	C18	100 pF	101	Dipped Monolithic Ceramic NP0, blue or tan body, 0.1" lead spacing
	C26	100 pF	101	Dipped Monolithic Ceramic NP0, blue or tan body, 0.1" lead spacing
	C20	120 pF	121	Dipped Monolithic Ceramic NP0, blue body, 0.1" lead spacing Reform the leads to match the 0.2" spaced pads
X	C20a	10 pF	10	Dipped Ceramic Monolithic NP0 <i>not supplied with kit, see page 23</i>
X	C31	22 pF	22J, 22, or 220	Dipped Monolithic Ceramic, tan body, 0.1" lead spacing DO NOT INSTALL YET
	C16	220 pF	221	Dipped Monolithic Ceramic NP0, blue body, 0.2" lead spacing

	C23	390 pF	391	Dipped Monolithic Ceramic NPO, blue body, 0.2" lead spacing
	C3	4.7 μ F	4.7 uF	Aluminum Electrolytic, 0.1" lead spacing, observe polarity, longer lead is +
	C6	4.7 μ F	4.7 uF	Aluminum Electrolytic, 0.1" lead spacing, observe polarity, longer lead is +
	C9	4.7 μ F	4.7 uF	Aluminum Electrolytic, 0.1" lead spacing, observe polarity, longer lead is +
	C13	4.7 μ F	4.7 uF	Aluminum Electrolytic, 0.1" lead spacing, observe polarity, longer lead is +
	C22	470 pF	471	Dipped Monolithic Ceramic NPO, blue body, 0.2" lead spacing
	C12	47 μ F	47 uF	Aluminum Electrolytic, 0.1" lead spacing, observe polarity, longer lead is +
X	C33	TBD	TBD	<i>Optional – not supplied with kit – see Appendix F</i>

Bottom Side Components

Install C21 and C30, the two pink trimmer capacitors (20 pF).

These mount on the bottom side of the board, soldered on the top side.



Notice the case has a flat side. Orient the flat side to match the outline on the component silkscreen on the bottom of the board, as in the photo at right. This ensures the adjusting screw is grounded, to minimize interaction with an adjustment tool.

Preset both trimmers to maximum capacitance as shown in the photo at left (use a magnifier).

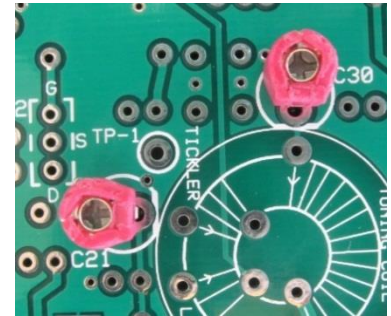

\checkmark	Ref	Value	Description
	C21	4-20 pF	Trimmer Capacitor (pink)
	C30	4-20 pF	Trimmer Capacitor (pink)

Transformer

Next, wind the toroid L1. It contains three separate, independent windings.

During the alignment of the receiver, to set the tuning range and regeneration control span, you may need to squeeze together or spread out the turns of the main winding and/or the tickler winding.

*To make this process easier it is recommended that you install the toroid on the bottom side of the PCB. This would allow adjustment of the trimmer capacitors and the toroid's windings to be accomplished without having to remove the front panel. The silkscreen outline is duplicated on the bottom to assist you. Actual performance of the receiver is not impacted whichever you choose. Do not be concerned that it appears the windings of a bottom mounted toroid would be in the opposite directions. It is only the **relative direction** of the windings that matters. Notice that each winding has one turn that is labeled with an arrow. This is the end from which the winding begins, coming up from the PCB, passing over the top and down through the center of the core.*

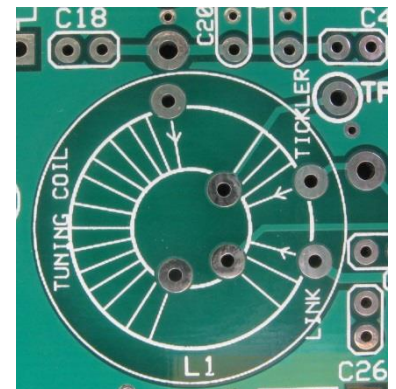

It is **essential** that this inductor be wound properly with the correct number of

turns, the proper winding direction, and location. By following the diagram on the PCB silkscreen successful construction can be assured. For additional help with winding, read the notes at <http://wa0itp.com/toroidophobia.html>

An additional tip – often the first couple of turns are difficult to get pulled up snug against the core, so wind two extra turns, and when that’s done, unwind the first two turns, leaving a nice tight winding.

Once you have decided on which side to install the toroid, refer to the photos below as a guide to winding the turns in the correct directions. Don’t worry if the numbers of turns in the photos below differ from these instructions – it’s the direction that matters.

Note that the core in the photos below is a yellow T68-6 core, but you have been supplied with a white T68-7 core, which has a slightly better temperature coefficient.

Locate the T68-7 (white) toroid core, and the 24 AWG magnet wire. Wind the main tuning coil: Wind **19 turns** (19 are pictured). Remember: turns are counted as the number of times the wire passes through the center of the toroid. It is essential that the turns are pulled snugly around the toroid, so that there is no slack between the wire and core. When complete, cut the wire ends to about 1/2”.

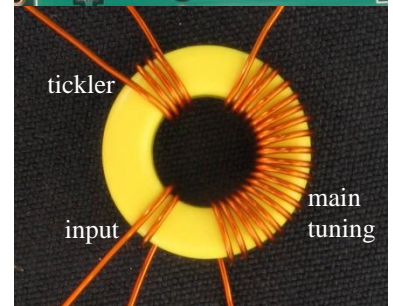
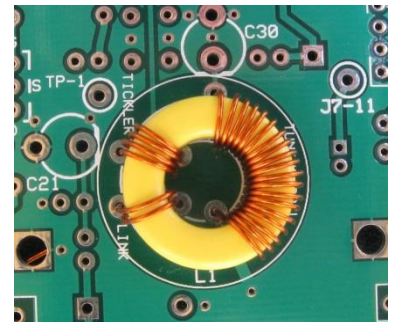

L1, shown wound for, and mounted on, the bottom side of the circuit board

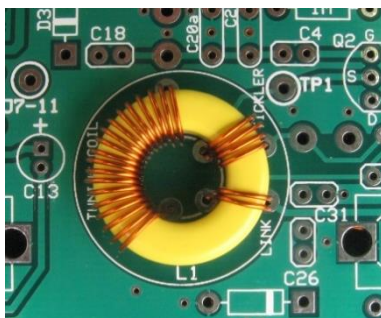

Next wind the tickler. Wind **4 turns** (4 pictured) of 24 AWG magnet wire for the tickler winding. Cut the wire ends to about 1/2”.

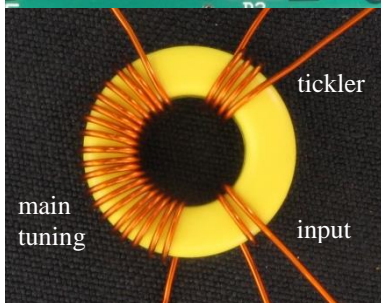

L1, shown wound for, and mounted on, the top side of the circuit board

Finally, wind the input link.

Wind **2 turns** (2 pictured) of AWG 24. Cut the wire ends to about 1/2”.

Strip and tin each of these wire ends prior to inserting on the PC board. Then pull the leads up snugly and solder them in place.

There are several methods for stripping the insulation from magnet wire. The wire provided in the kit is thermally strippable. With a higher wattage or thermostatically controlled soldering iron, the heat (at least 750 degrees F) will be sufficient to strip the insulation from the wire. Alternately, insulation may be removed using sandpaper or a sharp hobby knife, prior to tinning.

Test and Instrument Connection Points

Provisions are made on the PC board to install several wire loops that can be used to conveniently clip test instrument leads. There are three groups of five pads (the middle pad is not used). Two of the pad sets are grounded, and one set is connected to the +12 V supply. Each set is identified on the silkscreen legend. Use discarded resistor leads, forming them into loops. At each of the three groups of pads, install one loop on the top of the board and one loop on the bottom. Solder the top side loop on the bottom, and solder the bottom side loop on the top. *Be sure that the loop at the +12 V point will not be so tall as to interfere with the LED to be installed underneath the front panel.*

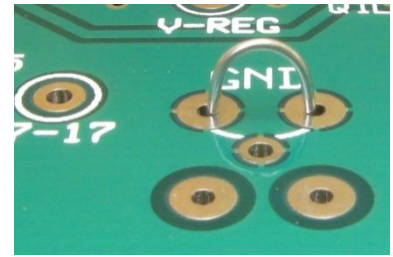

There are four places where single square post header pins are to be installed.

At the pads labelled **GRN/RxVcc** and **RED**, as shown, insert the short end of a pin down through the top of the board and solder at the bottom. A bit of masking tape may help to keep the pin in position.

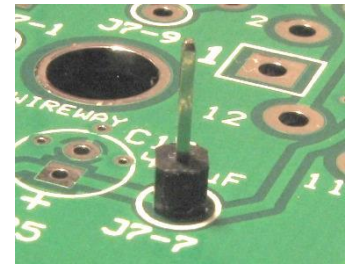

At pads **V-reg**, and **TP-1**, insert the long end through the board from the top, and solder on the bottom, as shown at right. This is done because these are just test points, not connection pins for plug-in wires, so a short test pin is OK.



Wire Jumpers

Install wire jumpers, using discarded resistor leads, at **JP1** (near R8) and at **JP4** (near R5) on the top side of the PC board. Form the jumper into a loop in the same manner as the test points. Should you at a later date wish to open that jumper to install a modification, all that will be necessary is to cut the loop and slightly separate the conductors.

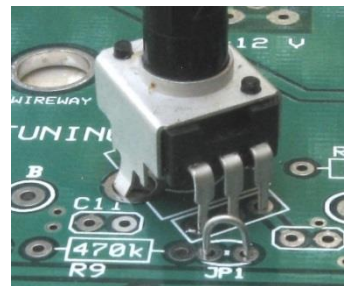

Inspection prior to final assembly

Inspect the PC board closely for unsoldered connections, cold solder joints, solder balls or splatter, improperly installed or incorrect components. Make corrections as necessary.

Final Main Board Hardware

Add the contact post for the built-in key. This is a 3/8" hex standoff. Install using a 3/8" screw **with at least two flat washers between the standoff and the PCB**. Two extra washers are provided in case the key spacing needs to be adjusted to suit the builder.

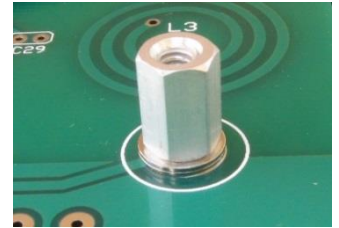

Prepare the Molex® connector socket pin inserts to create the crystal sockets. Take each of the inserts, and, using diagonal cutters, snip off the bottom 'fishtail' as shown in the photos below.

Using fine-nose pliers or a crimping tool, gently squeeze the crimp area marked on the photo until the pins are a snug fit into the holes in the board for the crystal socket.

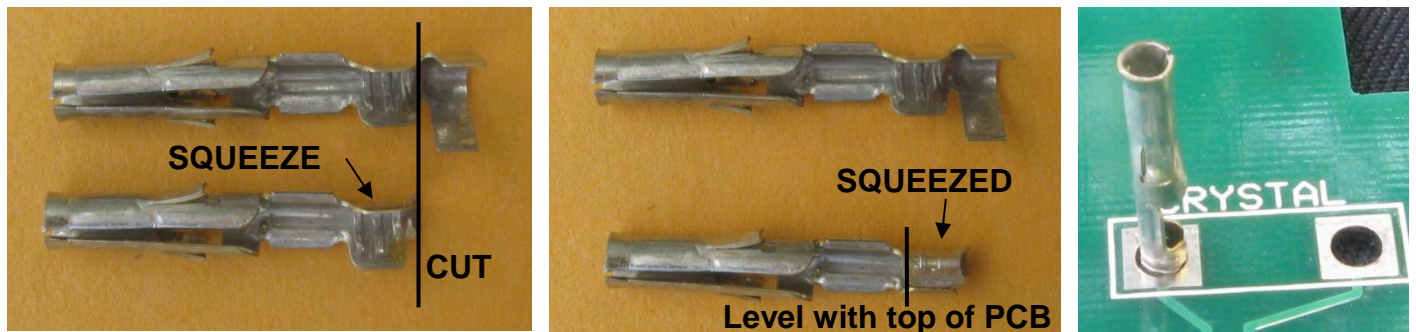

Make certain each pin is vertical before soldering, and adjust as necessary to correct any misalignment.

Front Panel Components

Assemble the built-in key. Locate the key leaf spring. This is a rectangular piece of 1/32" plated PCB with three holes. Install two 6-32x 3/8" screws through the top of the front panel. On the bottom of the board, slip the leaf spring over these screws, and mount using two hex nuts on the bottom. Use a small drop of clear fingernail polish on the end of the screws to keep the nuts from working back loose.

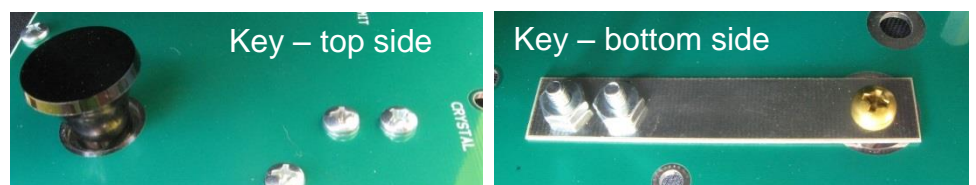

Mount the key knob onto the leaf spring by inserting it through the top of the front panel, and fixing it in place using the **8-32 brass** screw from beneath.

Assemble the power jack. Very gently bend the solder lugs of the power jack away from the body so that there will be sufficient clearance from the main board below. The lugs are fragile. A 90 degree bend may be too much and could cause the lug to break. 45 degrees should be enough. Strip 1/4" from the ends of the 3" red and black stranded wires. Solder the **red wire** to the solder lug on the **center pin** of the power jack, and the **black wire** to the lug connecting to the **outer shell** of the jack. Use an ohmmeter if not sure which lug is which. Orient the lugs as shown in the photo and on the silk-screened labels on the board, to minimize the chance of an accidental short circuit.



A matching power plug is supplied. Prepare that 12 V power plug with your choice of wire type and length so that 12 V can be applied to the circuit. A fused or current limited supply is recommended, at least for initial testing.

Mount the 1/8" plastic-body stereo headphone jack to the front panel by inserting it through the bottom and securing it with the included knurled nut.

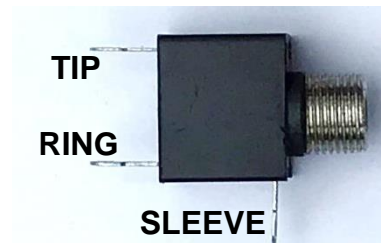

Mount the 1/8" metal-body mono external key jack to the front panel by inserting it through the bottom and securing it with the included knurled nut.



Cut four pieces of the 22 AWG tinned bus wire, each approximately 1 1/2" long.



Onto the plastic headphone jack, solder one piece of the bus wire to the **TIP** lug and another one to the **RING** lug. The **SLEEVE** lug is left unconnected. In fact you can cut off the **SLEEVE** lug if you wish - might help to avoid accidental shorts.



jack and plug pin arrangements

*There have been a couple of reported cases of the spring tabs inside the plastic jack touching one another when no plug is inserted. Visually inspect, and verify with an ohmmeter that there is an open circuit from the **TIP** to the **RING** lugs.*

Onto the metal external key jack, solder one piece of bus wire to the **TIP** lug and solder another one to the **SLEEVE** lug. The third lug is not connected (nc) and may be cut off if you wish.

If not already in place, install the six 5/8" hex standoffs to the bottom side of the front panel PC board using the 6-32 x 3/8" screws.

A new addition to the revB and revC kits is a red/green LED pilot light and Tx/Rx indicator feature. This bi-color LED indicator can be treated as an option. If, after reading through these instructions, you are uncomfortable with this "Pittsburg style" of assembly, you can simply omit these steps. There will be no effect on the performance of the transceiver.

Mount the two resistors:

R19 (1 K, BRN BLK RED)
and R20 (2.2 K RED RED RED) on the underside of the front panel. These are installed "Pittsburg style" as shown in the photos. Bend the leads to form, then trim, them as in the photo at right.



Solder both resistors to their pads as shown in the bottom photo, below.

The LED has three leads. See the photo at right. The longest lead is the common cathode (negative). The next longest is the RED anode (positive), and the shortest is the GREEN anode.



Install the bi-color LED (D4), also on the underside of the front panel, again Pittsburg style.



The cathode lead will be soldered to the pad marked GND.

The RED anode lead should be soldered to the pad marked RED.

The GREEN anode lead should be soldered to the pad marked GREEN.

Be sure to carefully observe the polarity of the LED leads as shown in the photo. Grasp each lead with a long-nose plier close to the body of the LED and gently form and trim the leads as shown, so that the LED will be positioned over the tuning index marker. Solder the middle lead, then re-check the positioning before soldering the other two leads.

□ Locate the 12” jumper wire supplied in the kit – the one with a header socket at each end. Cut the wire in half, then strip about 1/8” of insulation from each cut end, and tin the exposed wires with solder.

Solder one wire to the **GRN-RxVcc** pad on the underside of the front panel, and the other to the **RED** pad. It would be a good idea to use a bit of tape, or perhaps hot glue, to provide some strain relief for these wires.

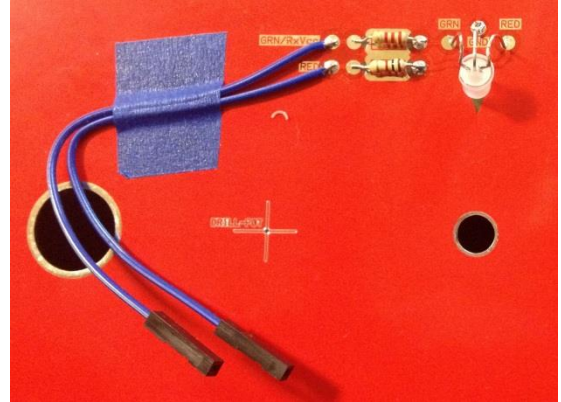

When the front panel is mated to the main PC board the socket ends of these wires will be plugged into header pins on the main board:

The wire from pad **RED** will plug into pin **RED**.

The wire from pad **GRN-RxVcc** will plug into pin **GRN-RxVcc**

The ground (common) connection will be made via the standoffs that join the front panel to the main board.

The sockets on the ends of the two connecting wires are just a bit too tall to fit between the front panel and the main board when they are plugged into the header pins.

*To make room, remove the little plastic spacer on each of the pins **GRN-RxVcc** and **RED**. Just grasp the plastic spacer with your long nose pliers and pull straight up. The plastic part will slide off. The photos show how.*

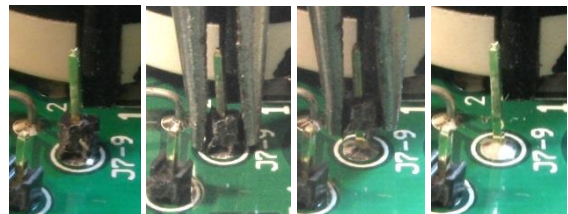

Here's how the bi-color LED indicator works:

When the transceiver is in Tx mode, 12 V is supplied to pin RED through SW1a.

Pin RED is connected through R19 to the red anode of LED D4. Diode D1 serves to isolate pin RED from the 12 V supply. Therefore the red portion of D4 will be illuminated in Tx mode.

When the transceiver is in Rx mode, 12V is supplied to pin GRN-RxVcc directly through SW1a, and is also connected to pin RED through diode D1. Now 12 V is being supplied through R20 to the green anode of D4. So during Rx mode the GREEN portion of D4 will be illuminated, in addition to the red portion.

The green portion of D4 is more efficient than the red, and the human eye is more sensitive to the green portion of the visible spectrum, so the green light overpowers the red, and the indicator appears green. If R20 were to be increased to about 24K to reduce the intensity of the green, the green light would roughly balance the red and the colors would mix to appear yellow/amber.

Keying Options

This revC Bayou Jumper includes the TIP-42 keying transistor (Q7) that is described in **Appendix K**, and which was installed in a previous step. The keying circuit may be configured three different ways by connecting the external key jack and installing jumper wires as illustrated below:

Keying Option 1: Both the on-board key and the external key control the transmitter keying circuit directly. Q7 is not used.

Connect a jumper wire from **ON-BOARD KEY** to **Tx-KEY**

In a later step, the **TIP** lug of the key jack will be connected to **Tx-KEY**

In a later step, the **SLEEVE** lug of the jack will be connected to **GND**

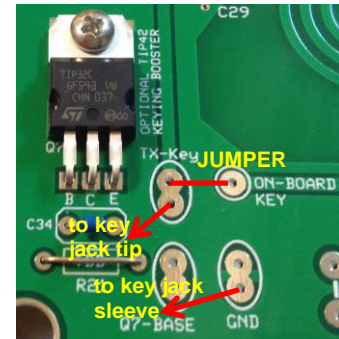

Keying Option 2: the on-board key is a direct keying line, but the external key utilizes the TIP-42 Q7 as a keying buffer.

Connect a jumper wire from **ON-BOARD KEY** to **Tx-KEY**

In a later step, the **TIP** lug of the key jack will be connected to **Q7-BASE**

In a later step, the **SLEEVE** lug of the jack will be connected to **GND**

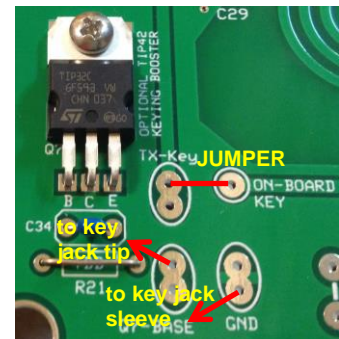

Keying Option 3: Both the on-board key and the external key use Q7 as a keying buffer.

Connect a jumper wire from **ON-BOARD KEY** to **Q7-BASE**

In a later step, the **TIP** lug of the key jack will be connected to **Q7-BASE**

In a later step, the **SLEEVE** lug of the jack will be connected to **GND**

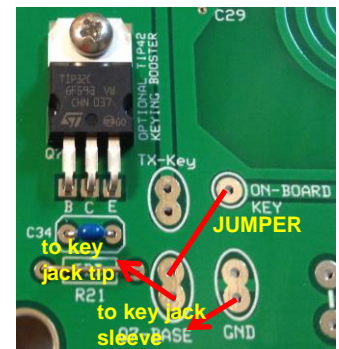

The builder can select the option that best suits to their operation. When an external keyer is to be used, option 2 or 3 should be selected unless the keyer already has an output circuit that can handle the several hundred mA of transmitter current.

Note: There is a small power penalty (about 0.5 dB) when using the Q7 keying buffer, but it generally results in a cleaner keyed waveform.

Mating the front panel with the main PC board

Place the front panel (with the six standoffs attached) onto the main PC board. Secure it temporarily with two or three screws. Re-check the motion of the pots. If they do not turn freely, re-heat the mounting lug(s), and adjust the angle(s) slightly as needed.

Remove the front panel temporarily. The power jack, key jack, and headphone jack should still be mounted on the front panel.

Review the keying options on page 19 and make your selection before connecting the key jack to the main board.

Route the wires from the headphone and key jacks through the appropriate holes in the board as you bring the boards together. **Don't Solder Yet.** You'll likely find that you need to gently bend the **TIP** and **RING** lugs of the headphone jack outwards to ensure there is clearance between the lugs and the main circuit board.

Route the red wire from the power jack to the square '+12 V' pad on the PC board, and the black wire to the round '—' pad on the board. Also, plug in the two wires from the LED into the header pins marked **RED** and **GRN/RxVcc**.

Finish attaching the front panel using the rest of the six 6-32 x 3/8" screws. Gently pull the bus wires from the headphone and key jacks to take up any slack. Now you can solder them into place on the circuit board. Solder the two wires from the power jack as well. **Inspect the power jack lugs and wire leads to be sure there are no accidental short circuits.**

If the crystal pins are not centered under the front panel holes, re-heat the solder and reposition them. Push two plastic insulating sleeves into the crystal socket holes in the front panel, pressing them down over the crystal socket pins.

Install the five knobs. Be sure the round knobs are positioned so that the set screws bear upon the flatted portions of the shafts. The knob indicators should line up with the markings on the panel. The rotary switch has no flat. Adjust its knob so that it lines up with the three positions marked on the panel. See

Appendix C for some additional comments about the main tuning knob.

□ Install the ½” male-female threaded standoff on the top of the front panel near the BNC jack. The standoff replaces the supplied 3/8” 6-32 screw that is normally inserted there. Use the 3/16” 6-32 screw on top of the standoff so that the phillips screw head provides a “landing pad” for the crystal pin.



Should you need to separate the main board from the front panel for adjustments or troubleshooting, remove the nuts from the key, headphone, and power jacks, and remove the knobs. The crystal socket pins will slide out of the nylon insulators with some gentle pulling.

Crystal Adapters

The Bayou Jumper has a front panel crystal socket to fit FT-243 or FT-241A crystals, the old style Novice crystals that can still be found at hamfests. The kit includes two HC-49 packaged crystals, for 7.030 and 7.122 MHz. These are the two QRP *watering hole* frequencies where much of the QRP activity takes place. Also included are two adapter boards that you can use to build your own FT-243-compatible crystals. If your adapters look different from the ones in the photo below, see **Appendix H** for additional information.

Assembly of the crystal adapters is pretty straightforward. Trim the leads of the HC-49 crystals and bend them so the body of the crystal sits flat on the board. Solder them down to the two round pads. Cut two lengths of #10 bus wire about 5/8” long, and solder down to the two rectangular pads. Check the spacing against the crystal socket on the PCB. Using a fine file or emery board, taper the ends of the #10 wires so they insert into the sockets smoothly.

As an alternative to the #10 solid wire, you can obtain 3/32” brass tubing or rod at Hobby Lobby or other hobby or hardware stores.

If the builder has any of the old style FT-243 or FT-241A crystal holders, the miniature HC-49 size crystals can be mounted inside the cases for a truly vintage appearance!

To mount the “tall” HC-49U crystals in an FT-243 case may require some hollowing out to create enough space. They will fit very nicely in an FT-241A case, needing nothing more than perhaps filing down the contact posts slightly.

HC-49S crystals, the “low profile” ones, will fit either case with no modification.

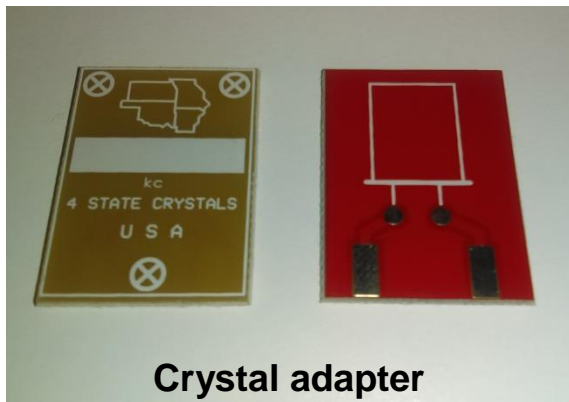

Crystal adapter



FT-241A



FT-243

Receiver Tuning Setup

With all board-mount components installed, the next step is to set up the receiver for the desired tuning range, and the regeneration control for the proper range. A calibrated CW receiver or a calibrated 40 m signal source is needed, or use the Bayou Jumper’s spotting function to calibrate the receiver.

Connect the 12 V power plug cable to a regulated 12 V supply or battery. A fused or current limited supply is recommended, at least for initial testing. Insert the plug into the 12 V power jack. With the radio OFF it will draw a few μA from the supply through the ESD protection circuit, when ON and in RECEIVE it will draw around 25 mA.

Appendix M lists some expected values of supply current and RF output.

Be sure to read **Appendix L** before connecting anything other than a standard set of stereo headphones or an unpowered speaker to the PHONES jack. The audio output amplifier IC chip will be damaged by improper connections.

Plug headphones or unpowered computer speakers into the PHONES jack of the Bayou Jumper. The isolated stereo jack is wired to place the left and right earpieces in series.

Turn the Bayou Jumper power switch to the RECEIVE position. Turn the ATTEN, and REGEN controls to their fully clockwise positions, the VOLUME to about mid-scale, and the TUNE control to the lowest frequency position (fully counter-clockwise). You should hear a hiss in the headphones, indicating that the receiver audio is operating.

If you have a frequency counter or oscilloscope with a high-impedance probe, you may sample the oscillator frequency at the test point labeled TP1 on the back side of the board.

Otherwise, if you have a calibrated CW or shortwave receiver, turn it on, and make sure it is in the CW mode. Place the Bayou Jumper next to it. Sweep the receiver tuning from roughly 6.0 MHz to 8.0 MHz. Somewhere within that range you should hear the oscillations of the regenerative detector, which initially will probably be below 7 MHz.

Alternately, if a calibrated receiver is not accessible, a separate transmitter may be used to generate a calibration signal. Connect the transmitter into a dummy load, and connect a short length of wire to the BNC connector of the Bayou Jumper. Tune the transmitter to 7.050 MHz, and key it. Rotate the tuning control of the Bayou Jumper until you hear the transmitted signal, which should fall at approximately halfway through the tuning range. If it is not heard, re-adjust the transmitter to 7.0MHz or 7.1 MHz to see if the signal can be heard.

Finally, if neither of these options is available, the transmitter spotting feature allows you to use the transmitter master oscillator as a reference signal. Insert the 7.030 MHz crystal into the crystal socket, place the Bayou Jumper power switch in the RECEIVE position, and turn the ATTEN control fully counter clockwise. Turn the VOLUME control knob to the 10 o'clock position, and the REGEN control fully clockwise. Depress the key knob, and rotate the TUNING knob through its range. You should hear two heterodynes, and the receiver will be tuned to 7.030 at the midpoint between the two. This point should occur at approximately the '3' position on the tuning knob.

If no signals are heard, the regenerative detector may not be oscillating. Jump ahead to the **Regeneration Setup** section to adjust the regeneration range.

If the frequency of the Bayou Jumper regenerative oscillator is not "close enough," you may use the trimmer capacitor C30 to adjust the frequency of the oscillation. Using a fine jeweler's screwdriver, rotate the trimmer capacitor setting approximately 1/8 of a turn at a time until the desired frequency is set.

If the trimmer capacitor C30 has insufficient range (it can shift the tuning range by a bit more than 200 kHz), you may squeeze together the turns of the toroid transformer L1 to lower the oscillation frequency, or spread them further apart to increase the frequency, then use C30 for final adjustments.

If the tuning range is still not satisfactory using both C30 and by adjusting the turns spacing of L1, your course of action will depend on whether the frequency range is too low or too high.

Should you need to separate the front panel from the main circuit board, remove the mounting nuts from the POWER, PHONE and KEY jacks. The front panel can be removed without having to de-solder anything.

If the tuning range is too low – below the 7000-7150 kHz range – and you have spread out the turns of the 19 turn winding as far as possible, you will need to remove a turn from that winding. Just cut the wire where it emerges from the PCB on the outside of the core and pull the wire out from under the core to remove one turn. Use a solder sucker or solder wick to clean out the hole, and feed the wire back through to gauge its new length. Pull it back out to strip and tin the end then re-insert, snug it up, and solder in place.

If the tuning range is too high – and you have squeezed the 19 turn winding as tightly as possible there are two possible actions, *to be taken only after you have verified that C4 and C20 have not been accidentally swapped.* C20 should be 120 pF (marked “121”)

1) Add some additional capacitance to the tank circuit by installing an additional capacitor at C20a. A 10 pF NP0/COG capacitor (not supplied with the kit) would be a good starting choice.

2) Or, you may add a turn to the main winding of L1. This probably requires completely removing the toroid – though, with care, you could re-wind 20 turns while the core is still attached by the other two windings.

Adding more capacitance will have the additional effect of slightly reducing the width of the tuning range, while adding inductance (extra turn) has the opposite effect. The tuning range in either case should still be more than adequate to cover the portions of the band needed.

Once one of these processes has been done, repeat the calibration steps to set the range of the tuning control.

Regeneration Setup

The next step in receiver setup is to adjust the regeneration control range. Check out the MP3 audio clips posted in the Files area of the Bayou Jumper Group <<https://4sqrp.groups.io/g/BayouJumperKit>> if you are unfamiliar with

how a regen receiver should sound.

Set the TUNING control to the middle of its range, the VOLUME control to mid-range, and listen to the headphone audio. It may help if an antenna is connected to the Bayou Jumper. Rotate the REGEN control knob from maximum to minimum, and back. You should notice a marked change in the audio hiss in the headphones at some point along the knob travel, as the detector JFET Q2 enters and exits oscillation. This should occur near the midpoint of its travel. If this is not the case there are two likely scenarios:

(1) If there is no change to the hiss while adjusting the REGEN control, it means that the regeneration must be adjusted to either increase or decrease the amount of RF feedback in this circuit. If, for any setting of the REGEN control, you can hear the heterodyne of the Bayou Jumper's regenerative oscillator in your separate calibrated receiver, or, hear the signal of a nearby CW transmitter or the spot frequency when keying, then you have too much regenerative feedback.

(2) If no signals are heard, or the detector oscillations cannot be found in the test receiver, then the detector may not be oscillating because there is too little feedback through the tickler winding.

In either case (1) or (2) above, the first step is to adjust trimmer capacitor C21, next is to squeeze or spread the 4 turns of the tickler winding, and as a last resort, adding or removing a turn from the tickler winding. It is very unlikely that the tickler should have to be re-wound.

Adjusting the tickler winding and trimmer capacitor C21

Set the regeneration control, R10, about 30% of its clockwise travel. Set the main tuning to the low frequency end of the tuning range. Try to set C21 so that oscillation just begins (as evidenced by the increase in hiss in the audio) then back off C21 until the detector just barely drops out of oscillation. At this point the regeneration control, R10, should be able to bring the detector smoothly in and out of oscillation near the 30% - 50% point of its travel.

If it does not appear that the detector oscillates for any setting of C21, try squeezing the 4 turns of the tickler winding more tightly together. If still no oscillations, or oscillation only starts near the extreme CW rotation of the control, install the optional ceramic capacitor C31 (22 pF) and repeat the above procedure.

Conversely, if the detector always oscillates, no matter the setting of C21 or R10, be sure that C31 is NOT installed, and spread out the turns of the tickler winding. If that does not allow the detector to cease oscillating, decrease the value of C26. A good first try would be 82 pF followed by 75 pF.

If, on the other hand, you are not hearing any oscillations in your separate CW receiver, or hearing any CW notes in your Bayou Jumper Receiver when connected to an antenna, then you have insufficient regenerative feedback. In this case, install C31, the 22pF capacitor, and re-test.

Re-check the receiver calibration. It's a good idea to do a final check with the radio installed into its box, but before screwing down the panel.

When the receiver calibration is satisfactory, to fix the turns in place, paint the toroid with a light coating of clear fingernail polish.

Finally, secure the panel to the box's wood posts with the four #6 sheet metal screws. Be careful not to overtighten them, which could strip the threads you're cutting into the pre-drilled wood posts.

Troubleshooting

It will probably be best to un-mate the main and front panel boards to allow easy access for testing and troubleshooting. Remove the knobs and connector retaining nuts. Remember that the LED indicator will not work unless its wire leads are plugged in and a ground path exists between the main and front panel boards.

If your Bayou Jumper does not operate after assembly, repeat the visual inspection of solder joints. Especially inspect the leads of L1 for good solder connections. Compare the component placement diagram with the instructions to be certain that all components were installed in their correct locations. In particular, be sure that C20 and C4 have not been interchanged, which would make the tuning range too high in the band. C20 should be 120 pF and C4 should be 100 pF.

A check of voltages at strategic locations on the board while under power can serve to isolate problems to a particular circuit. The table on the next page lists nominal voltages for the unit in receive and with the regeneration control fully counterclockwise.

If an entry is marked 'XXX' do not attempt to measure it.

The XXX voltages are at high impedance RF points where a DC reading will possibly be erroneous due to the high RF voltage present, or the stray capacitance of the voltmeter probe could cause the circuit to misbehave.

For those who may be experiencing the charm of a regenerative receiver for the first time, there are a series of MP3 audio files posted in the Files area at: <https://4sgrp.groups.io/g/BayouJumperKit>, the Bayou Jumper Kit Support Group. These give examples of what the receiver should sound like under various tuning conditions. The file names explain to what you are listening.

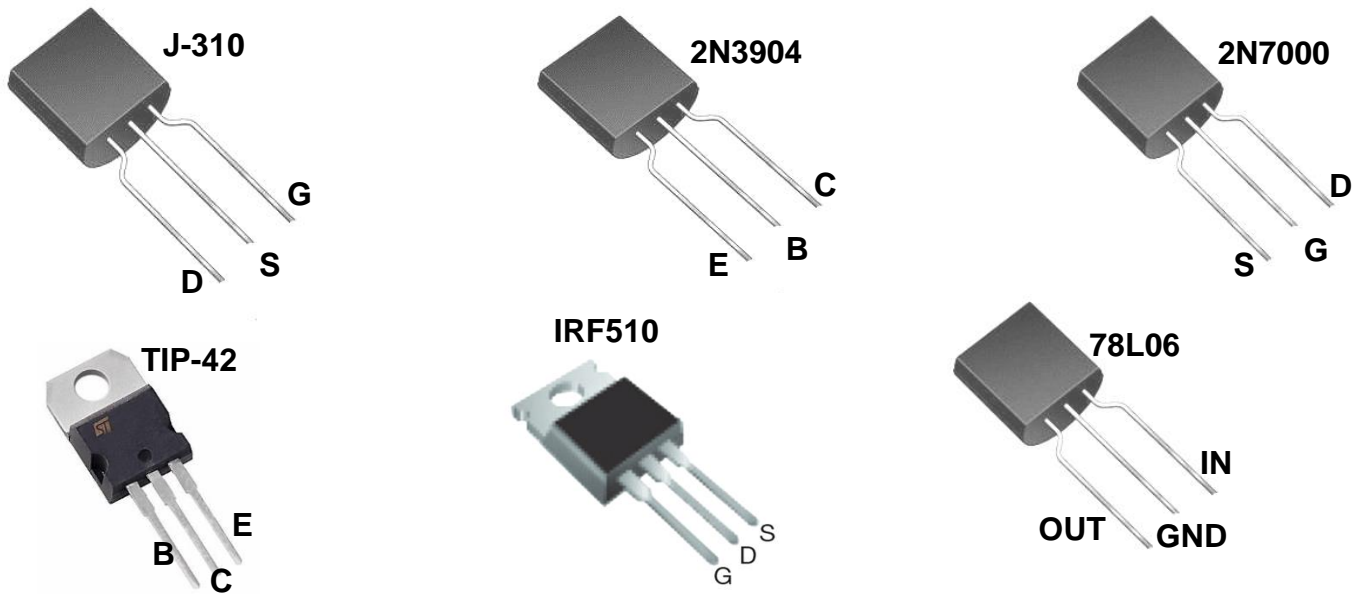

Voltage Chart -- values are approximate, based on a 12.0 V power supply

Component ID	Pin	Expected V	Measured V
Q1	E	5.4	
	B	6	
	C	6	
Q2	G	0	
	D	1.5 to 3.5 V for revC, revA and earlier, about 0.6V for revB	
	S	6	
Q3	E	0	
	B	0.65	
	C	between 2 & 4	
Q4	G	xxx	
	D	12	
	S	xxx	

Q5	G	3	
	D	12	
	S	xxx	
Q6	G	12	
	D	0	
	S	0	
Q7 voltages for key options 2 or 3		The key that is pressed must be the one wired to Q7 base	
Q7, Rx, key up	E	1.5	
	B	0.7	
	C	nearly 0	
Q7, Rx key dn	E	- 0.6 (yes, negative!)	
	B	nearly. 0	
	C	nearly. 0	
Q7, Tx key up	E	1.6	
	B	0.8	
	C	nearly 0	
Q7, Tx key dn	E	0.75	
	B	nearly 0	
	C	nearly 0	
U1	1 (square pad)	0	
	2 Vref	5.7	
	3 +IN	5.7	
	4 -IN	5.7	
	5 OUT1	5.7	
	6 Vcc	12	
	7 GND	0	
	8 OUT2	5.7	
U2	1 (OUT) nearest C2	6	
	2 (GND) middle	0	
	3 (IN) nearest C25	12	
R8	WIPER PIN	2 to 6 as R8 is varied	
R10	WIPER PIN	0 to 6 as R10 is varied	

Operating the Radio

Operation of the Bayou Jumper is fairly straightforward. Make sure you are operating into an antenna with good VSWR – 1.5:1 or better. The transmitter in the Bayou Jumper is not overly sensitive to VSWR, but it has no built-in protection against very mismatched loads that could cause damage. It is best to use a tuner with a resistive-bridge type VSWR sensor, such as the 4SQRP 4S-Tuner.

Make sure there is a crystal inserted into the socket before transmission. Turn on the receiver and verify that you hear signals.

To spot the transmitter crystal frequency, first turn the ATTEN control fully counter-clockwise (minimum signal). Turn the REGEN control fully clockwise. Turn the VOLUME control to the 10 o'clock position. Press the key – in the RECEIVE setting, only the Master Oscillator is activated, and no signal is transmitted. Rotate the tuning control. As you rotate the control, you will hear two loud regions of heterodyne whistle noise, with a dead zone in the middle, caused by the oscillator RF overloading the regenerative detector. You won't be able to zero-beat exactly, but you can come close knowing the transmitter frequency is in the middle of the two noise regions.

See **Appendix G** for an alternate method of spotting the crystal.

Returning the REGEN, ATTEN, and VOLUME controls to their normal positions, you will likely hear signals. You can either call CQ or reply to a call as you would with any other rig – just be aware that you cannot change the transmit frequency without changing crystals! If you plan to work other Bayou Jumpers, be sure to tune around a bit after calling CQ – just like back in pioneer times!

There is an on-line Group devoted to the Bayou Jumper at

<https://4sgrp.groups.io/g/BayouJumperKit>

There is large and active community of builders who can help each other with issues that may arise, so new builders are encouraged to join up!

Once you have your Bayou Jumper built and working, apply for a Secret Agent Number and get a matching serial number decal for your radio. See the Bayou Jumper web page, in the documentation area, for details



Four State QRP Group
BAYOU JUMPER revC
 26 May 2021
 NM0S/N51B

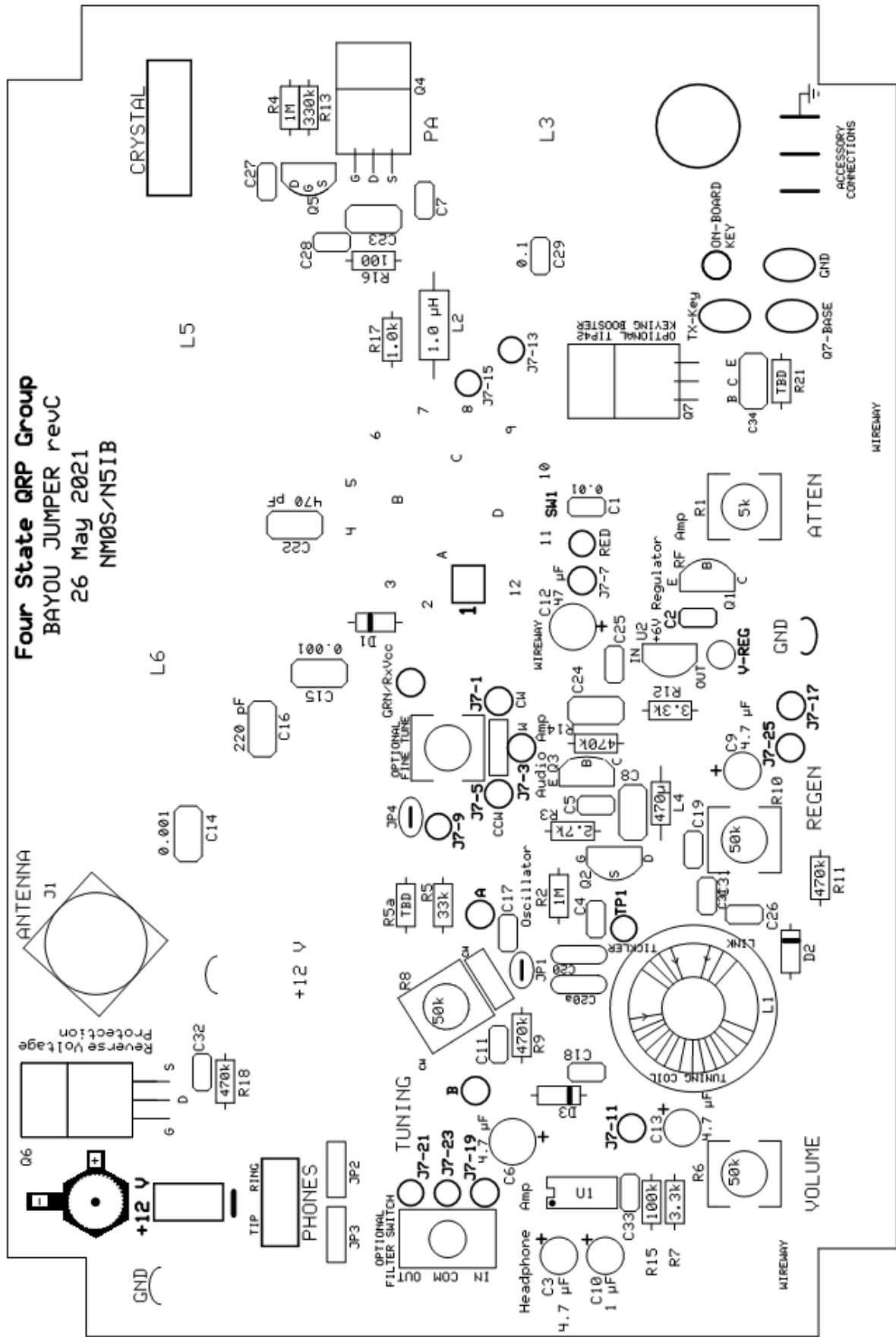

Top copper pattern and silkscreen, viewed from top side

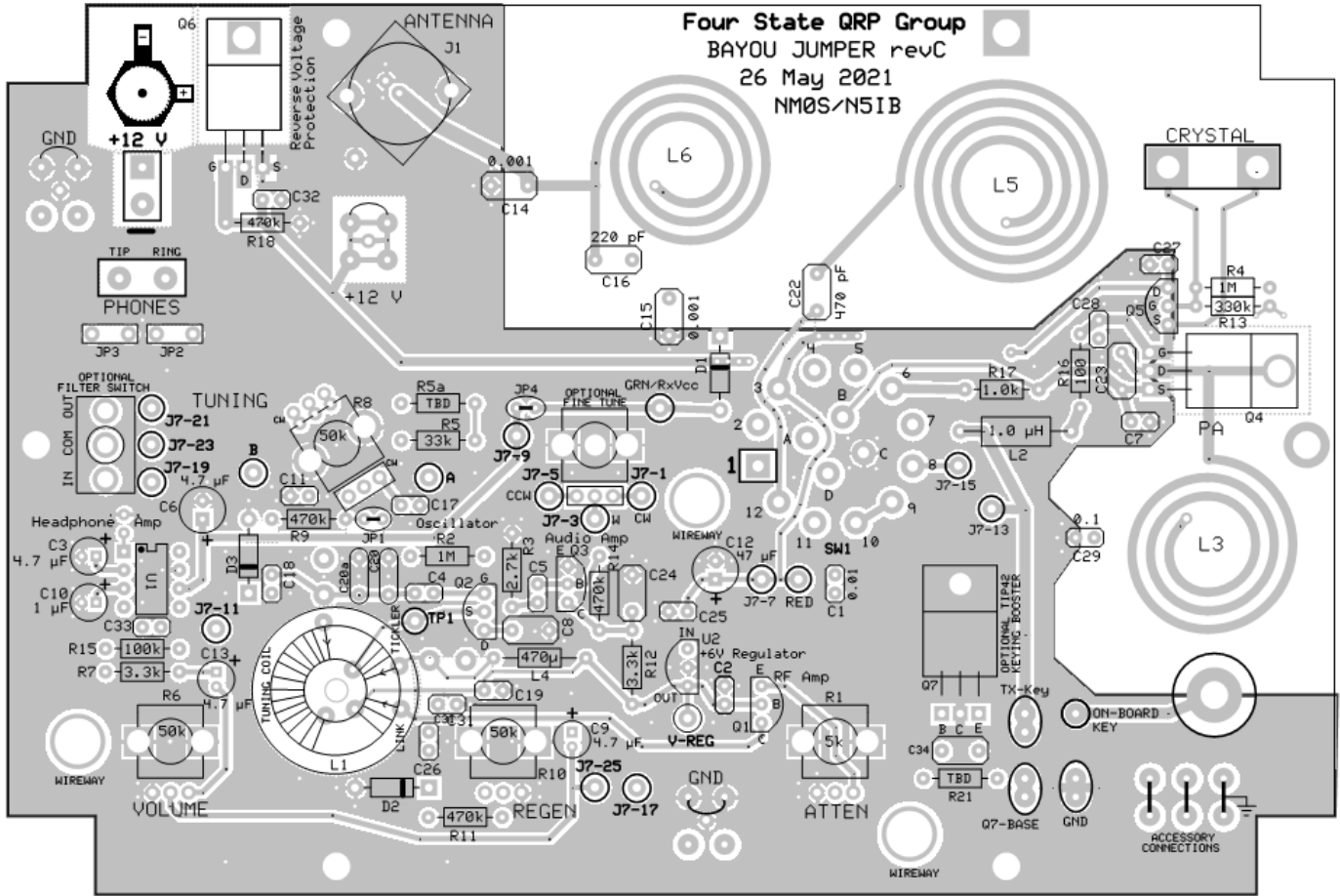

Bottom copper pattern and silkscreen, viewed from bottom side

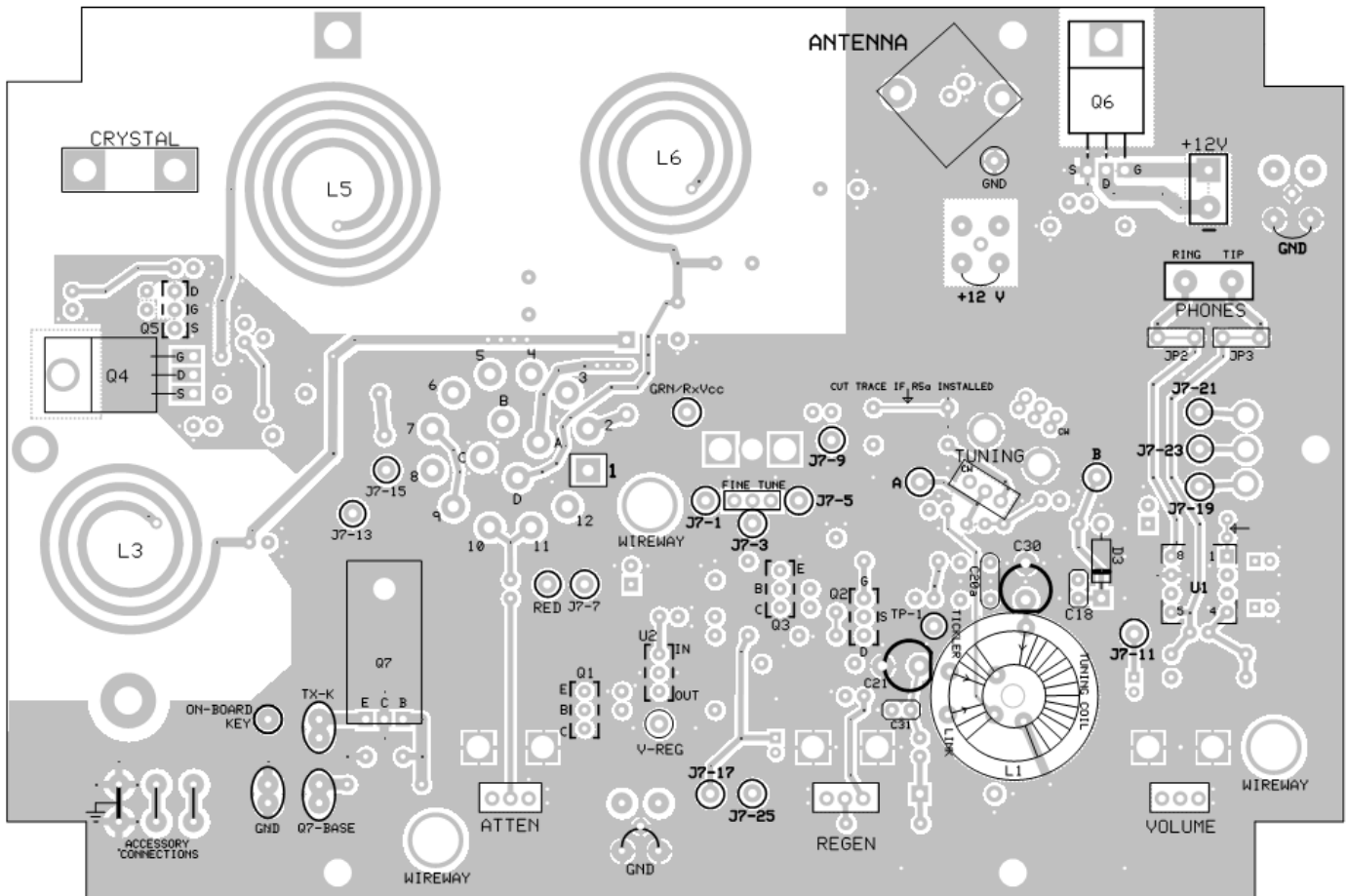

Front panel, top and bottom views

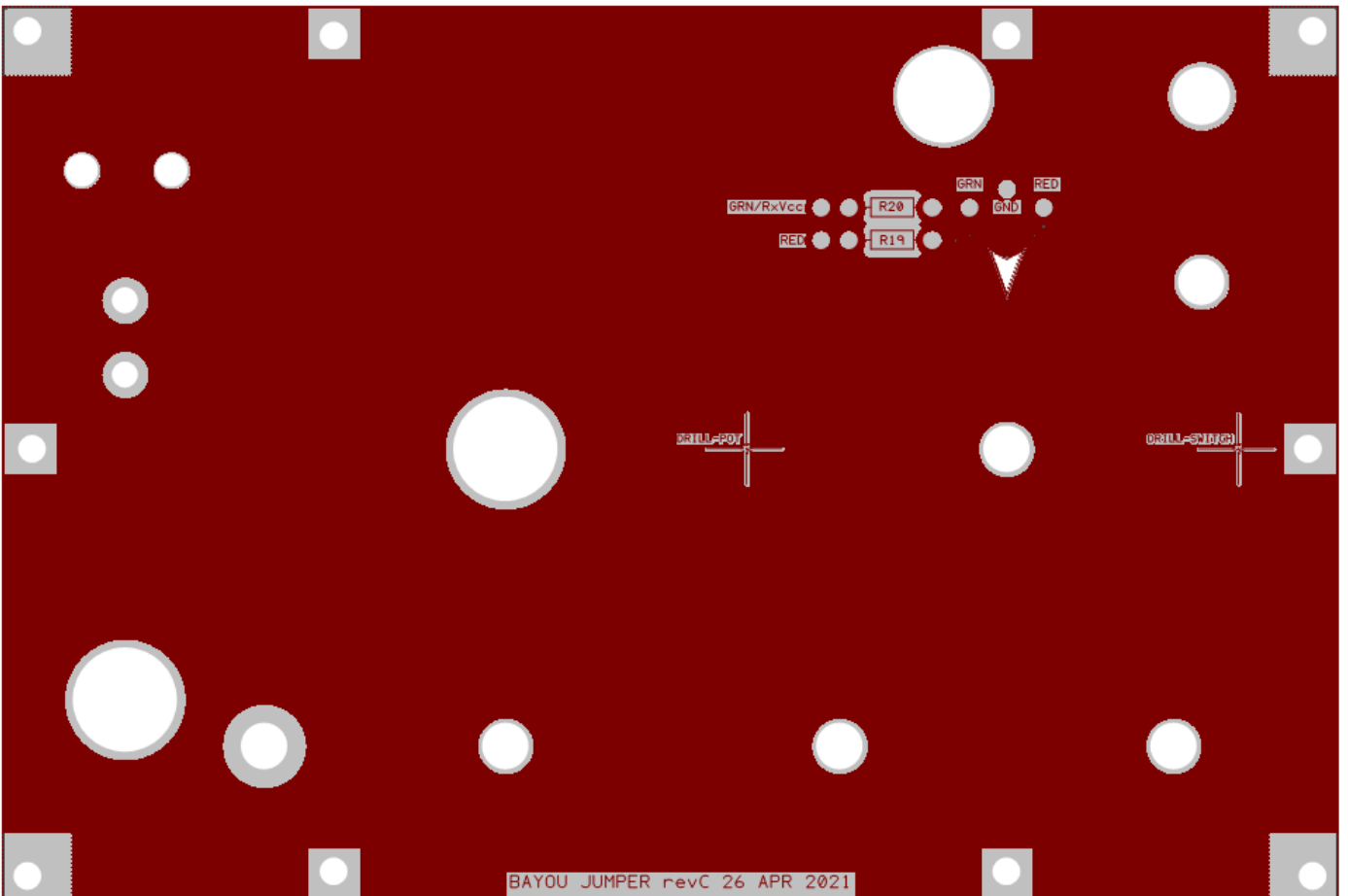
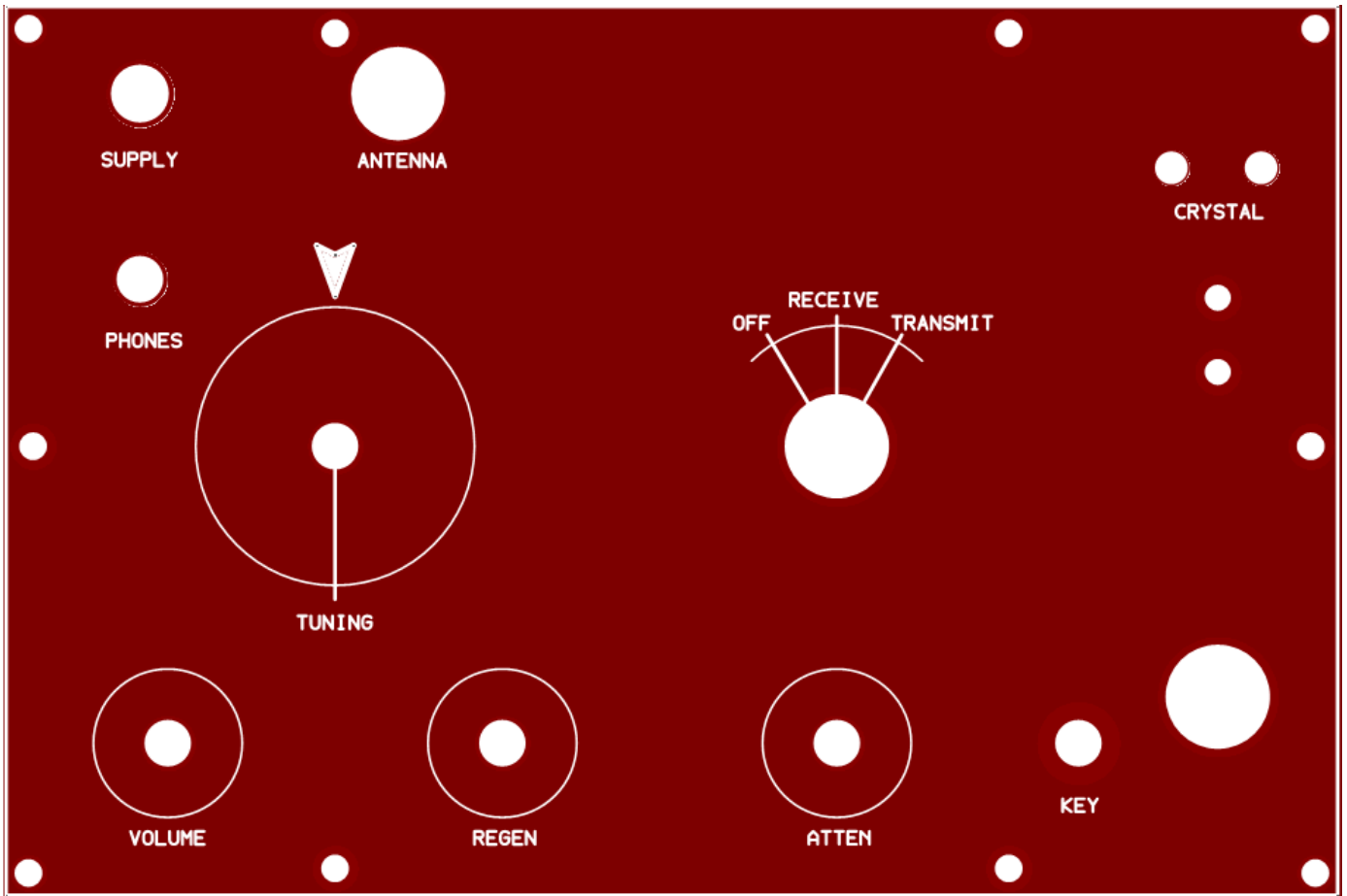

Photos by NØSM.

Top: Populated PCB, note builder's choice to use insulated wire for jacks

Bottom: Populated PCB, bottom view, with toroid (white T68-7) mounted on bottom

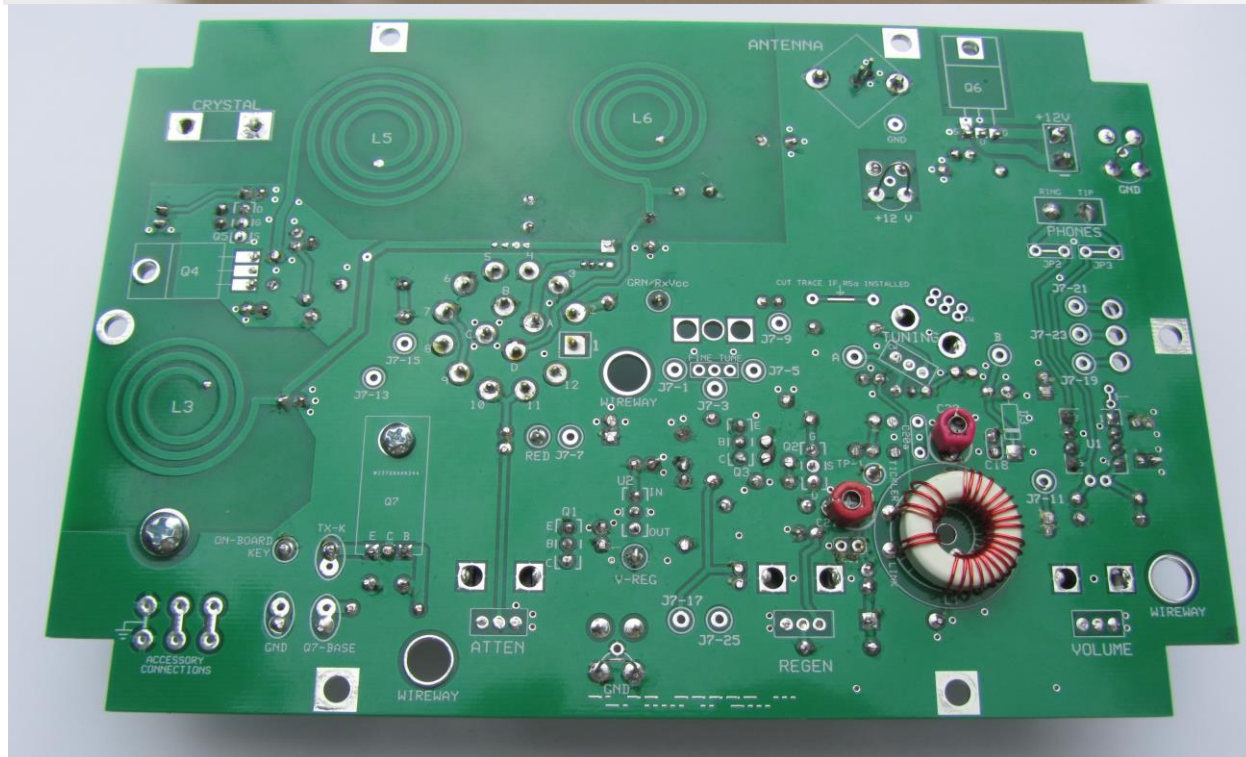
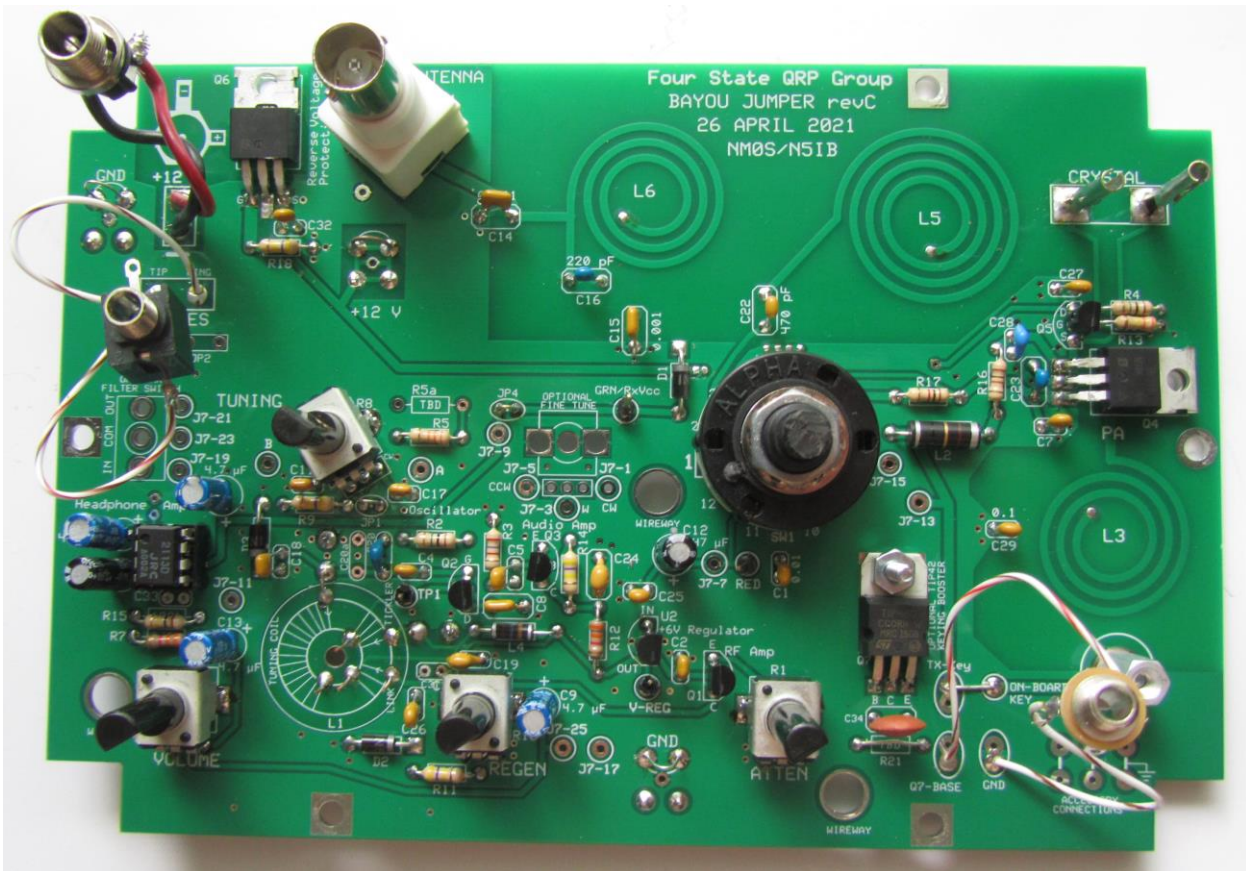

Underside of front panel, showing standoffs and LED connections

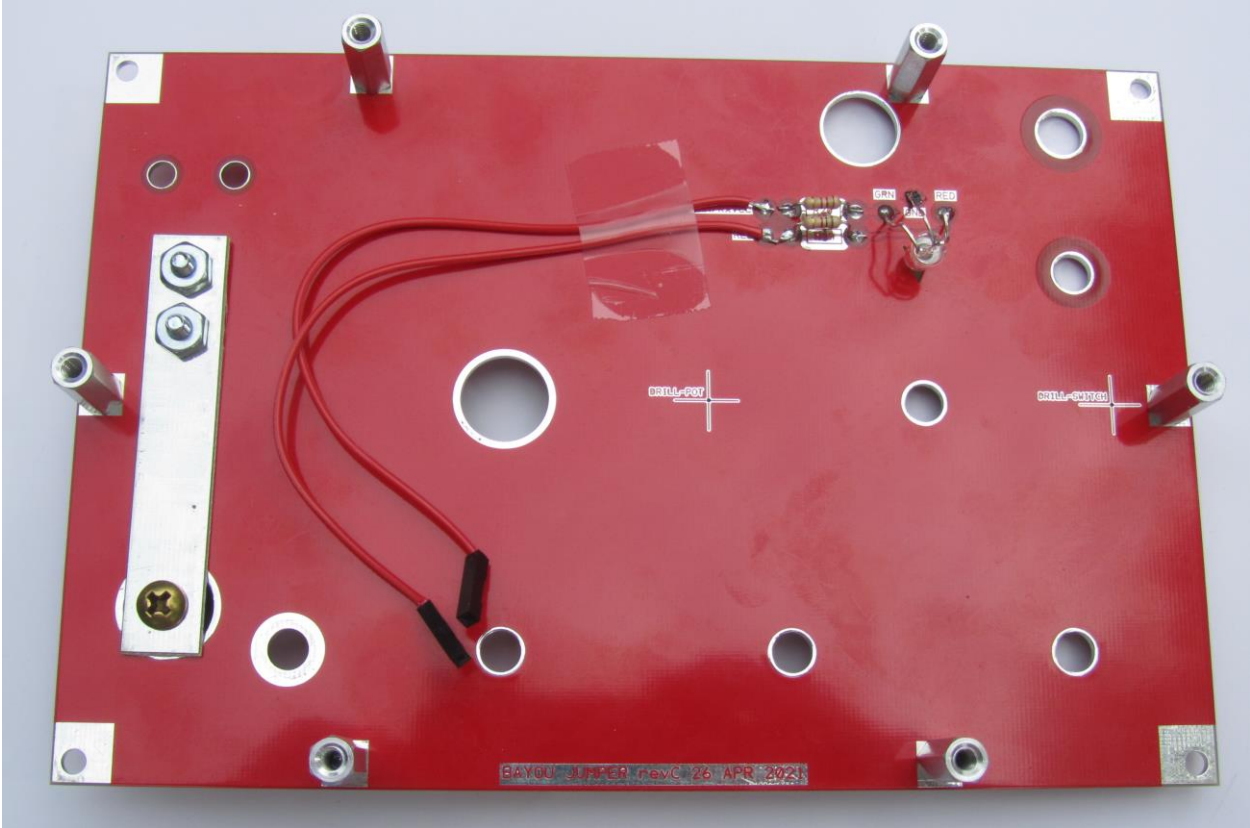

Design Notes

- Tuning range approximately 140 to 160 kHz – enough to cover the Extra Class CW band through the old “Novice Band.”
- One knob tuning – no bandset/bandspread needed.
- Only one toroid to wind in the receiver section. Etched PCB inductors used in the transmitter section.
- Varactor tuning employing readily available Schottky diodes as varactor diodes. Regeneration control also employs a “Schottky varactor” as the throttle capacitor.
- Use of potentiometers controlling only the DC bias on the varactors for tuning and regeneration means the controls are not “hot” with RF, so “hand effect” detuning is minimized.
- RF attenuator control, which is useful when employed with full-scale antennas.
- Robust headphone audio, and will drive a small speaker with modest volume.
- Current drain on receive about 20 to 25 mA, less than 600 mA on transmit at 5 W
- Harmonics and spurious down about 50 dB with respect to the fundamental, exceeding the FCC 43 dBc requirement.

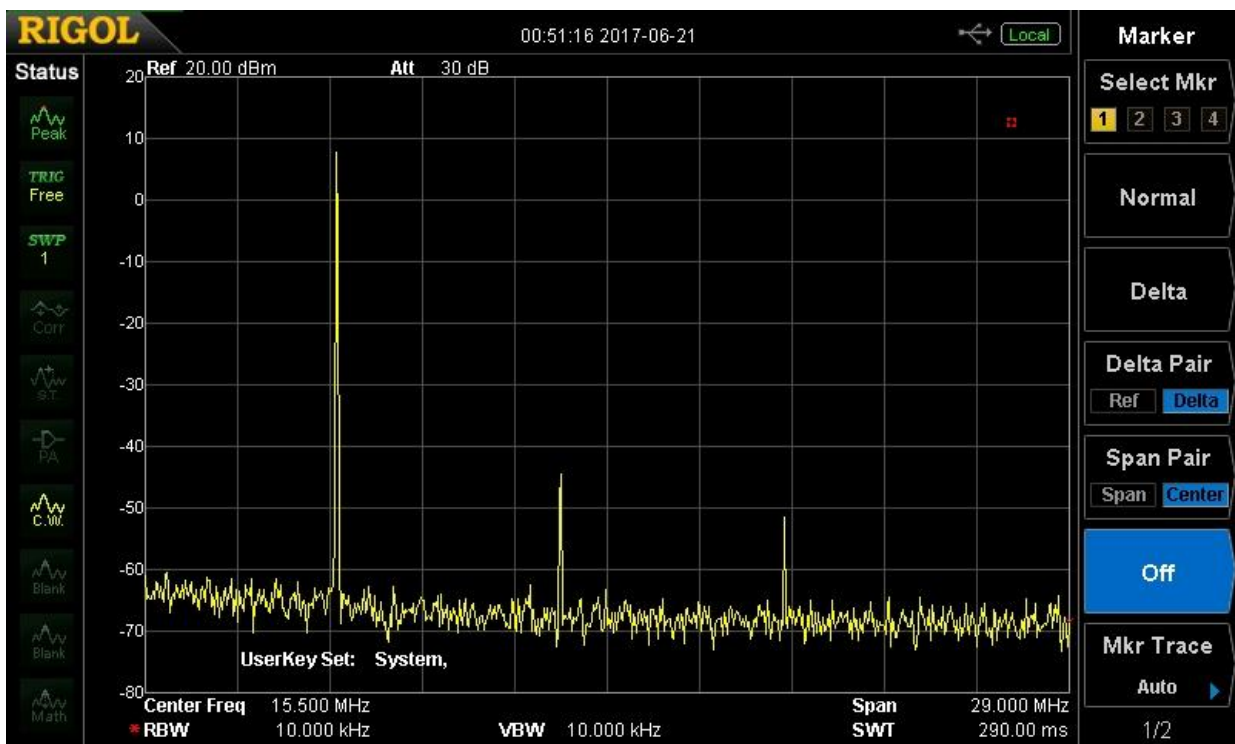

Bayou Jumper rev C (Red Panel) Bill of Materials (21 July 2021)

Inv√	Quant	Part ID(s)	Description	Marking	Notes
			CAPACITORS		
	1	C31	22 pF NP0 ceramic, 0.1" LS	22J , 22, or 220	Optional - do not install yet
	2	C21,C30	4-20 pF trimmer capacitor	pink body	Note orientation of flat side
	3	C4, C18, C26	100 pf NP0 ceramic, 0.1" LS	101	
	1	C20	120 pF NP0 ceramic, 0.2" LS	121	
	1	C16	220 pF NP0 ceramic, 0.2" LS	221	
	1	C23	390 pF NP0 ceramic, 0.2" LS	391	
	1	C22	470 pF NP0 ceramic, 0.2" LS	471	
	3	C8, C14, C15	0.001 μF 200V NP0 ceramic, 0.2" LS	102	
	1	C28	0.0033 μF NP0 ceramic, 0.1" LS	332	
	4	C1,C2,C11,C17	0.01 μF ceramic, 0.1" LS	103	
	1	C24	0.033 μF ceramic, 0.2" LS	333	
	7	C5,C7,C19,C25, C27,C29,C32	0.1 μF ceramic, 0.1" LS	104	
	1	C34	0.22 μF ceramic, 0.2" LS	224	
	1	C10	1 μF electrolytic, 0.1" LS	1 μF	Note polarity
	4	C3,C6,C9,C13,	4.7 μF electrolytic, 0.1" LS	4.7 μF	Note polarity
	1	C12	47 μF electrolytic, 0.1" LS	47 μF	Note polarity
			DIODES		
	3	D1, D2, D3	1N5819 Schottky diode	1N5819	Note polarity
	1	D4	Red/Green bi-color LED, 5 mm, common cathode, water clear lens		Note polarity, installed under front panel
			CONNECTORS		
	1	J1	BNC jack		Antenna
	1	J2	2.1x5.5 mm coaxial power jack		Power input
	1		2.1x5.5mm coaxial power plug		Mates with J2
	1	J3	1/8" mono jack, metal frame		Key
	1	J4	1/8" stereo jack, plastic housing		Phones
	2	J5, J6	Molex® female pins		Crystal socket
			INDUCTORS		
	1	L1	T68-2 iron powder toroid core	Yellow body	
	1	L2	1.0 μH molded choke	Wide Silver-Brown-Gold-Black-Silver	L2 is the physically larger choke
	1	L4	470 μH molded choke	Wide Silver-Yellow-Violet-Brown-Silver	L4 is the physically smaller choke
			TRANSISTORS		
	2	Q1, Q3	2N3904 NPN BJT, TO-92	2N3904	
	1	Q2	J-310 JFET, TO-92	J-310	
	2	Q4, Q6	IRF-510 MOSFET, TO-220	IRF-510	Static sensitive
	1	Q5	2N7000 MOSFET, TO-92	2N7000	Static sensitive
	1	Q7	TIP-42 PNP BJT, TO-220	TIP-42	

RESISTORS				
1	R16	100 Ω 1/4W 5% resistor	BRN-BLK-BRN	
2	R17, R19	1.0 K 1/4W 5% resistor	BRN-BLK-RED	R19 is installed under the front panel
1	R20	2.2 K 1/4W 5% resistor	RED-RED-RED	R20 is installed under the front panel
1	R3	2.7 K 1/4W 5% resistor	RED-VIO-RED	
2	R7, R12	3.3 K 1/4W 5% resistor	ORG-ORG-RED	
1	R5	33 K 1/4W 5% resistor	ORG-ORG-ORG	
1	R15	100 K 1/4W 5% resistor	BRN-BLK-YEL	
1	R13	330 K 1/4W 5% resistor	ORG-ORG-YEL	
4	R9,R11,R14,R18	470 K 1/4W 5% resistor	YEL-VIO-YEL	
2	R2, R4	1.0 M 1/4W 5% resistor	BRN-BLK-GRN	
POTENTIOMETERS				
1	R1	5.0 K potentiometer	B5 02	
3	R6, R8, R10	50 K potentiometer	B5 03	
SWITCH				
1	SW1	4-pole 3-position rotary switch		
INTEGRATED CIRCUITS				
1	U1	NJM2113 audio amp DIP-8	NJM2113	Use supplied socket
1	U2	78L06 voltage regulator TO-92	78L06	
CRYSTALS				
1	X1	7030 kHz quartz crystal HC-49	7030	
1	X2	7122 kHz quartz crystal HC-49	7122	
2		Crystal Adapter PC board	Cajun Crystals	
OTHER HARDWARE				
1		Front panel PC board	Rev C	red solder mask
1		Main PC board	Rev C	green solder mask
2		Nylon screw insulator/bushing		Use with J5 & J6
1		“chicken head” pointer knob, will require an Allen wrench, 1.5 mm		OFF-Rx-Tx switch
3		Small control knob		VOLUME, REGEN, ATTEN controls
1		Large dial knob		Main tuning
4		2” long x 3/8” square wood post		For box mounting
15		3/8” #6-32 machine screw		For standoffs
6		5/8” #6-32 F-F hex standoff		Board-to-board
1		1/2” #6-32 M-F hex standoff		For xtal test post
1		3/16” #6-32 machine screw		For xtal test post
1		3/8” #6-32 F-F hex standoff		For CW key
1		Key knob		For CW key
4		#6-32 hex nuts		For CW key
1		PCB ”leaf spring” lever		For CW key
4		#6 flat washers		For CW key
1		3/8” #8-32 BRASS screw		For CW key
4		#6-32 sheet metal screws		joins panel to box
1		#4-40 x 1/2” machine screw		For Q7 mounting
1		#4-40 nut		For Q7 mounting

	6 ft		AWG #24 enameled magnet wire		For toroid L1
	9 in		AWG #22 tinned bus wire		For jacks and jumpers
	6 in		AWG #10 bare copper wire		For crystal pins
	3 in		RED/BLACK insulated wire		For power jack
	12 in		“Dupont” female-female jumper wire		LED connections
	5	TP1, V-reg, GRN/RxVcc, RED	Header pins, 1 conductor		1 spare supplied
	1		DIP socket 8 pin		Socket for U1
			Optional parts (Not supplied with kit) for modifications		See manual appendices
		R5a	TBD, could be potentiometer		
		C33	TBD, approx. 560 pF		
		R21	TBD – optional component		
		Filter switch	SPST miniature toggle		For Soup’er Up’er
		Fine Tuning	1K potentiometer Bourns series PV09, 25 mm shaft, center detent Bourns PTV09A-4225F-B102		For Soup’er Up’er Same physical size & type as R1
		C20a	10 pF NP0 ceramic, 0.2” LS	10	In case needed to move tuning range lower

APPENDICES

A. Rotary Switch Options

In case the indexing key washer should slip out of place while working with the switch, the photo at right shows the correct position of the washer relative to the index post on the body of the switch.

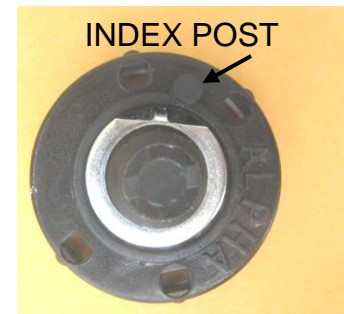

The shaft of the stock switch is a little too long to allow the selector knob to sit down close to the panel. It will not interfere with closing the lid of the recommended box, but if the appearance is not to your liking you can shorten the shaft. **Be sure to leave at least 1/4" of shaft remaining.** The best procedure is to hold or clamp the end of the shaft (so as to not apply stress to the switch body, and use a jeweler's saw, fine hacksaw, coping saw, or a band or scroll saw. Alternatively a cutoff disk in a Dremel tool could be used. It is even possible to use diagonal cutters, but don't try to make one clean cut through the shaft, best to nibble away until the desired length is attained. NA1MH's photo at right shows such a shortened shaft.

B. Key Stiffness

The spring lever of the built-in key is made of thin double-sided PCB stock. If the touch feels too light, a replacement lever can be fashioned from thicker (1/16") stock.

Alternatively, the stock lever can be retained, but a "helper spring" made from 1/16" PCB stock can be installed as shown in the photo. The length of the helper plate will determine how much stiffness is added.

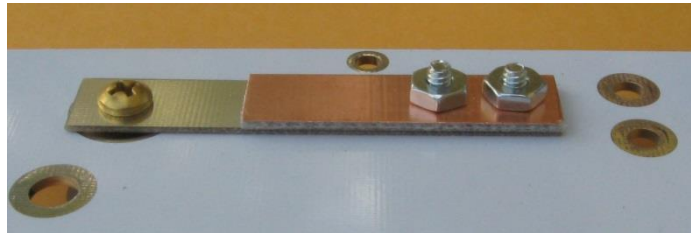

C. Main Tuning Knob

The metal skirt around the base of the tuning knob may have some rough edges that could scratch the finish of the panel. Use a piece of emery paper on a flat hard surface to sand the edge until it is flush with the plastic undersurface of the knob. A washer made of felt might be fashioned to slip between the knob and the panel, to prevent scratching and to provide some extra friction for the dial action.

D. Routing wires to the main PCB for installations of mods or accessories.

Since there is room under the main PCB as installed in the recommended box, the possibility of adding accessories such as an audio filter, sidetone oscillator, keyer, *etc*, are certainly attractive. Several “wireways” – pre-drilled ¼” holes in the circuit board – have been provided to allow for passing wires from above and below the main board. The holes are isolated from the top and bottom ground planes.

E. Tuning Range

An easy way to change the tuning range is to change the value of R5. Smaller resistance will increase the range, while larger resistance will decrease it. The downside of increasing the range is that the tuning will become more non-linear – tuning faster at the lower end of the band. R5 should not be decreased below about 5 to 10 k or so.

A pair of pads, designated **R5a**, have been provided. They are shorted across with a thin trace on the bottom of the PCB that must be cut if **R5a** is to be used. Inserting extra resistance, or better still, a potentiometer, at **R5a** will move the bottom of the tuning range up in frequency, while leaving the upper end virtually unchanged. So if most of the use of the radio were going to be in the 7100 to 7125 kHz region, it could be spread out over nearly the full travel of the main tuning control. But the range could be easily restored to cover the lower part of the band.



A potentiometer at **R5a** does act rather like a fine tuning control, but its effect is greatest at the low end of the range, diminishing to no effect at all at the top end.

F. PCB footprints for optional additional components (not supplied in the kit)

Mounting pads and connection points have been provided for an additional potentiometer (of the same physical type as the others in the kit) and a miniature SPDT toggle switch. Adjacent to each are a set of pads that can be used to make wire connection to the parts.

Possible uses for the potentiometer could be a fine tuning control, a keyer speed control, a sidetone pitch or level control. Bourns 9 mm pots, series PTV09A, 25 mm shafts, will fit the footprint.

The SPDT switch could switch an audio filter in or out, or select resistors at R5a to change the tuning range. Marlin P Jones # 25010SW (ON-OFF-ON), or similar, fits the footprint.

On the underside of the front panel are centering marks to allow drilling a hole properly positioned for these optional parts.

A pair of pads are provided for an optional capacitor, **C33**, to be installed across the feedback resistor of the audio amplifier IC. A few hundred pF has been found to “mellow” the audio sound of the receiver. The larger the capacitance the more the highs are suppressed.

G. Crystal Spotting

Some builders may discover that the spotting feature does not suit their needs. The strong RF signal from the crystal oscillator, even when the final amplified stage is not in use, overloads the regenerative detector and pulls the detector to oscillate a frequency some kHz removed from the actual receive frequency as shown on the dial.

An outboard crystal spotting oscillator could be constructed. There is a description on the Bayou Jumper Yahoo Group of an example circuit.

Another method is to disconnect the antenna and connect the crystal across the antenna terminals. When the receiver is tuned across the crystal resonant frequency a “pop” or “thump” is heard in the receiver. The method is quite precise and allows setting the receiver within a few hundred Hz of the true crystal frequency.



To simplify this process the BNC antenna connector has been relocated close to one of the PC board mounting standoffs. Installing the 1/2” standoff (topped with with a 3/16” 6-32 screw) on top of the front panel, replacing one of the 3/8” 6-32 screws, allows an FT-243 sized crystal to be easily connected momentarily between the center pin of the BNC jack and the grounded standoff.

There is an MP3 recording posted on the BayouJumper Yahoo group site that demonstrates the sound of the receiver tuning past the crystal frequency.

H. Alternate Style Crystal Adapters

These adapters allow for a series trimmer capacitor and/or a series inductor to be added. The crystal is installed in the same manner as the originals but, if either the capacitor or inductor were to be added, cut the associated trace(s). The solder mask has been removed above those traces for better visibility.



The series capacitor will raise the frequency, while the series inductor will lower it. If both are used a somewhat wider range of adjustment may be attained.

I. Connection points for potential modification or additions

There are nineteen extra pads on the PC board that connect to strategic points in the circuit. These points have been selected because they may be useful for modifications or additions such as sidetone, audio filter, keyer, fine tuning, digital dial, etc.

Each point is identified on both the top and bottom silkscreens with a circle and an alphanumeric designator, as listed below. They are also identified on the schematics with the same designations.

- A connects to the wiper of the main tuning potentiometer, R8
- B connects to the cathode of the main tuning varactor diode, D3
- TP1 connects to the Q2 end of the tickler winding for scope or counter

- J7-1)
- J7-3) these pads connect to the terminals of the optional potentiometer
- J7-5)

- J7-7 connects to the +12 V supply during both Tx and Rx operation
- J7-9 connects to the +12 V supply during Rx operation only
- J7-11 connects to the input resistor of the audio amplifier IC, U1
- J7-13 connects to the internal key line
- J7-15 connects to GND during Rx, is floating during Tx
- J7-17 connects to the collector of the audio pre-amp transistor, Q3

- J7-19)
- J7-21) these pads connect to the terminals of the optional SPDT switch
- J7-23)

- J7-25 connects to the wiper of the volume control potentiometer, R6

- KEYER-TIP) These pairs of pads can be used to connect the stereo key jack to a
- KEYER-RING) keyer. Connect tip, ring, and sleeve from the jack to one pad of each
- KEYER-GND) pair, then use wire leads from the other pads to the keyer circuit

J. The NA1MH Soup'er Up'er Accessory

David Martin, NA1MH, designed an add-on for the Bayou Jumper that provides a sidetone, a fine tuning control, and the NMØS HI-PER-MITE audio filter.

This accessory is not currently being kitted and supplied by Four State QRP Group, but "previously owned" units are occasionally offered on various QRP forums, and documentation is available for download.

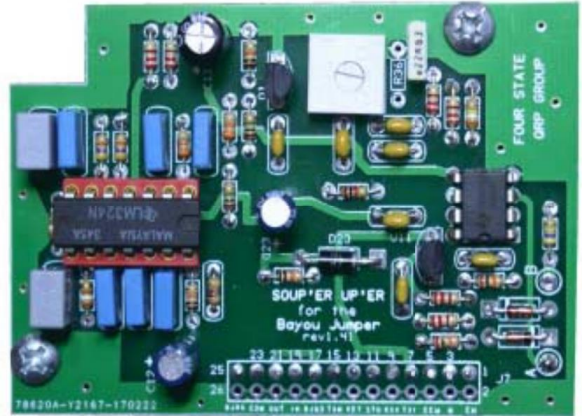

NA1MH photo of beta version

A small PC board is attached to standoffs under one corner of the main board and is connected to the main board using the connection points described in **Appendix I**, above. No trace cutting is required. Provisions for mounting a fine tuning potentiometer and filter IN/OUT switch have already been made on the revA circuit board (see **Appendix F**) and the underside of the front panel is marked to locate the holes to be drilled to accommodate the extra controls.



WØEB photo

K. Using a keyer

During transmit key-down intervals the keying current of the Bayou Jumper is about 750 mA, which will exceed the capability of many keyer output circuits. A robust PNP power transistor, a MOSFET power switch, or a relay, are called for.

In the special case of the Four State QRP Group's **EZ-Keyer**, the supplied BS170 output transistor could be replaced with a heftier MOSFET such as the IRF510.

Any one of the circuits at right, suggested by NMØS, could be used to interface between a conventional keyer and the Bayou Jumper.

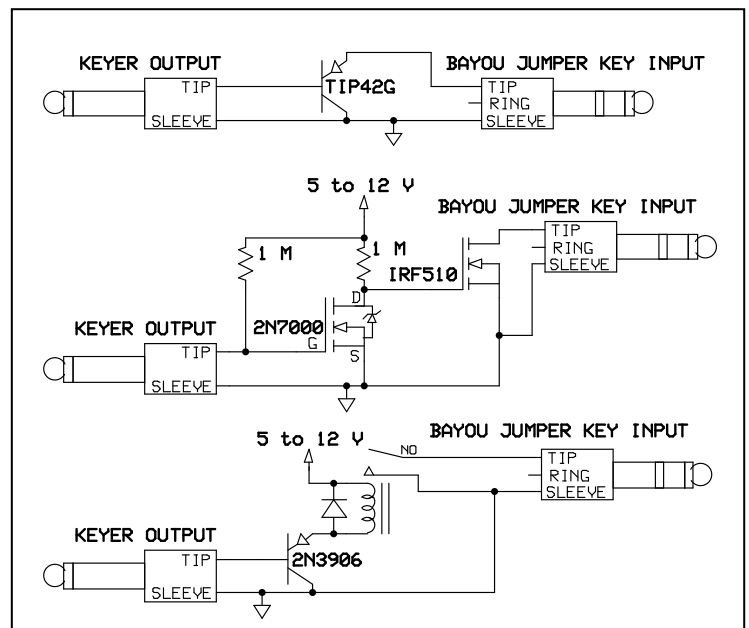

The upper, TIP-42, circuit is now standard equipment in the revC kit

L. Connecting external audio devices (amplifier, filter, etc)

The Bayou Jumper's audio amplifier device (NJM2113) employs a differential output stage which is not referenced to the circuit ground. That is why only the tip and ring contacts of the stereo jack are connected, and the sleeve is left floating. This type circuit does not require the large series capacitor such as used with LM386 amplifiers, and as a result, the low frequency response of the audio stage is improved.

But since both outputs of the IC are internally biased at approximately half the supply voltage, connecting either output pin to circuit ground will produce a short circuit which will irretrievably damage the chip.

If you want to use an external amplifier, or external narrow band audio filter (such as a NEscaf or HI-PER-MITE) you must use a DC blocking capacitor in series with both the tip and ring connections. Check the schematic of your external device. A blocking capacitor may already be in place in the signal lead, so you would only need to add one in the common lead.

Since most of these devices have a relatively high input impedance, the capacitance does not need to be very large – you may be able to use a common 0.1 μF capacitor. If an electrolytic capacitor is used, the positive side should be connected to the tip and/or ring of the headphone jack.

The diagram below illustrates a proper connection to a HI-PER-MITE audio filter (top) or other generic active audio device (bottom).

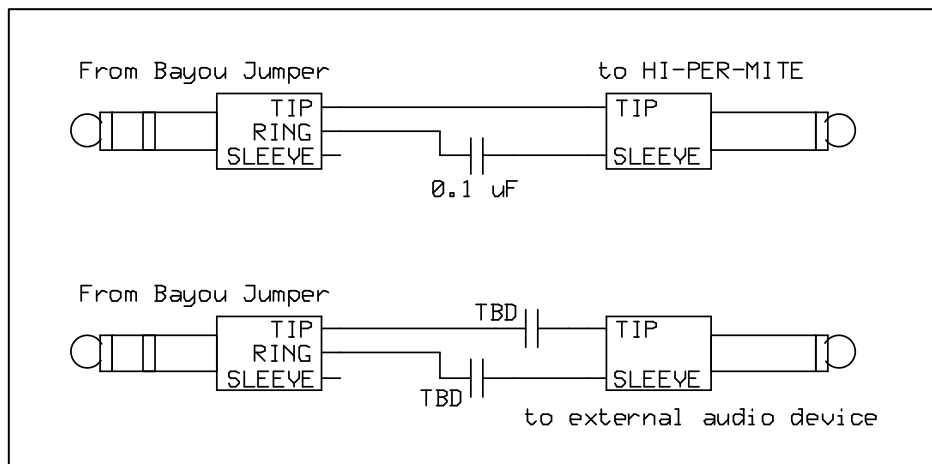

M. Measured values from a rev B, beta build Bayou Jumper

Tuning range:

Very tight 19 turn main winding

With C30 at maximum capacitance, initial range was 6813 – 6959 kHz

Adjusting C30, only, yielded the result below

Dial setting	Rx zero beat frequency, kHz
0	7002.0
1	7004.3
2	7030.1
3	7063.3
4	7087.7
5	7107.8
6	7125.6
7	7142.6
8	7159.3
9	7162.0

Receive mode current draw (12.4 volt supply):

Key up, normal headphone volume: 24 mA

Key down (spotting mode): 71 mA

Transmit mode, idling current (12.4 V supply):

Key up: 17 mA

Transmit power measurements:

All voltages measured at the power jack, key down, 7120.1 kHz (7122 crystal)

V _{supply} at power jack	RF output Peak-peak volts	RF output watts	Supply current mA	PA efficiency
11.0	35.2	3.1	360	78%
12.0	38.4	3.7	395	78%
13.0	41.6	4.3	425	78%
14.0	44.0	4.8	455	81%
Fully charged 12 V, 7 A-hr AGM battery	40.8	4.2		
3 x 18650 lithium-ion cells, fully charged	38.4	3.7		

Harmonic suppression measured with a Rigol spectrum analyzer:

All harmonics at least 50 dB below the fundamental

N. Critical Dimensions of PC Board and Enclosure

With some folks having trouble laying hands on the recommended Hobby Lobby box:

<http://www.hobbylobby.com/Crafts-Hobbies/Wood-Crafting/Unfinished-Wood/Wood-Rectangle-Box-Set-with-Silver-Handle/p/25426-GA0369>

The on-line sale is for a set of three boxes, of which the smallest is used.

The boxes can be purchased individually in stores, **SKU# 662536S**.

here are some dimensions which might help in a roll-your-own.

First the PC Boards:

They were designed on a decimal inches grid. The primary dimensions in those units, as specified to the manufacturer was:

7.186" long x 4.800" wide (182.525 mm x 121.920 mm)

actual measurements here, on a sample of two, agree within ability to measure (< 0.5 mm)

The front panel is a complete rectangle of those dimensions

The main PCB has 0.425" x 0.425" (10.795 mm x 10.795 mm) cutouts at the four corners

The PC boards are 1.6mm (0.063") thick

The four mounting holes at the corners of the front panel are 0.15" (3.81 mm) in diameter, and their centers lie on the vertices of a 6.925" x 4.550" (175.895 x 115.570 mm) rectangle

The Hobby Lobby "small box" dimensions, in mm:

(inside dimensions) 183 mm side to side, 123 mm front to back, and 52 mm deep.

cover is the same length and width, except the depth is 21 mm

the thickness of the wood sides is about 8 mm, and the top and bottom are about 2 mm thick.

To fit the completed kit into a box there must be a clearance, measured from the bottom surface of the front panel to the inside bottom of the box, of 28 mm (1.1"), and 20 mm (0.8") from the top surface of the front panel to the inside surface of the top of the box.

M. Rotating R8 to use the Alternate Tuning Index Mark

If you decide to rotate R8 so that the knob's numbered scale will align with the alternate index mark at the bottom of the dial, you'll need to install three wire jumpers as shown by the red, blue, and yellow lines in the photo at right. Install these jumpers on the bottom side of the PC board using the slightly smaller set of three pads, along with the unused set of "normal" R8 mounting pads. Do this only after R8 has been completely soldered in place, having used the larger set of three pads just above the "TUNING" label for R8's pins.

