

Assembly & Instruction Manual

Bayou Jumper

40 Meter CW Transceiver

For revD (Red Panel) kits shipped after 1 May 2022
Copyright 2017, 2020, 2021, 2022

David Cripe NMØS
Jim Giammanco N5IB
&
Four State QRP Group



NØSM photo

PLEASE READ THIS ENTIRE MANUAL
Including the APPENDICES
BEFORE BEGINNING ASSEMBLY

Introduction

Thank you for purchasing a Bayou Jumper transceiver kit. We hope you will enjoy building it and have many QSOs with it. This kit is comprised of high-quality components, a silkscreened, solder-masked, double-sided PC board and top panel, and hardware for mounting in a wooden enclosure.

This kit owes its genesis to the imagination of Jim Giammanco, **N5IB**, who envisioned this project in homage to the classic 'Paraset' transceiver, <http://www.paraset.nl/> the legendary spy radio from World War II. Using the same circuit architecture as the original, Jim brought it up to date with solid-state circuitry, giving the user an authentic feel of the original radio without the high voltages and scarce components of a tube circuit.



With a tip of the cap to his Louisiana heritage, Jim christened his creation the *Bayou Jumper*, after the popular KnightKit *Ocean Hopper* regenerative receiver kit that he and so many novice hams built a more than a half-century ago. His presentation on the project was one of the most popular sessions at OzarkCon 2016. The Four-State QRP Group is proud to be able to present the Bayou Jumper to the QRP community.



\$16 in 1955 is about \$160 today!

The transceiver is comprised of two separate circuits, a crystal-controlled transmitter and a regenerative receiver. The transmitter uses 4SQRP's super simple, super robust NS-40 transmitter circuit, with trademark on-board spiral PCB trace inductors, and between 4 and 5 watts output power.

The Bayou Jumper utilizes a regenerative receiver, the same as the original Paraset. No other receiver circuit provides the combination of sensitivity and selectivity with low parts count. Regenerative receivers were popular among hams for this reason. The receiver in the Bayou Jumper has been measured to have a Minimum Discernible Signal (MDS) of better than -120 dBm, which is as good as many commercial receivers. In the Bayou Jumper, the receiver tunes independently from the transmitter frequency, so there is a 'Spotting' function to

allow the user to tune the receiver to the transmitter frequency. Switching between transmit and receive is performed with a rotary switch, just as was done with the original Paraset. You cannot get more simple and reliable than that!

The entire transceiver was designed to fit inside a standard wooden box, available from Hobby Lobby. It can be ordered here:

<http://www.hobbylobby.com/Crafts-Hobbies/Wood-Crafting/Unfinished-Wood/Wood-Rectangle-Box-Set-with-Silver-Handle/p/25426-GA0369>

The on-line sale is for a set of three boxes, of which the smallest is used. The boxes can be purchased individually in stores, **SKU# 662536S**.

First Steps

Before getting started with building the kit, take some time to organize and familiarize yourself with the parts provided and check them against the Bill of Materials (pages 34 & 35). Building over a cookie sheet is recommended to minimize the chance of lost parts. If parts are missing in your kit, send an email to the kitter listed on the Bayou Jumper web page at:

<http://www.4sgrp.com/bayoujumper.php>

He will promptly provide replacements.

Schematics are provided separately as image files in the documentation package, as well as being incorporated into this manual. It is highly recommended that you print a couple of copies at 11 X 17 inch format at your local UPS Store, Staples, etc. As you build, use a highlighter to mark off parts that have been soldered onto the PCB on one copy. When you think you are done, you can check that copy to verify that all of the parts have been installed.

There is an active on-line Group devoted to the Bayou Jumper at

<https://4sgrp.groups.io/g/BayouJumperKit>

where a large community of builders can help each other with issues that may arise. The “Files” area there contains a large amount of background and supporting information. New builders are encouraged to join up.

Special Bayou Jumper on-air operating events, such as the popular “London Calling” evenings are announced on that Group.

Tools and Supplies

It is helpful to acquire these before starting assembly:

- *Soldering iron – ESD safe, 20-30W, preferably thermostatically controlled.
- *Small diameter (0.025” recommended) 63/37 or 60/40 rosin core solder
- *Wire stripper
- *X-Acto type hobby knife (#11 blade best)
- *Diagonal cutters (flush-cutting type preferred)
- *Needle-nose pliers
- *Fine file or emery board
- *Phillips screwdriver
- *Allen wrench: 1.5mm – for the pointer knob’s set screw
- *Hand drill with 1/8” bit
- *Non-metallic alignment tool
- *Fine jeweler’s screwdrivers
- *Electrical tape
- *Clear fingernail polish
- *Wood glue
- *Clamps or spring clothespins
- *Magnifier
- *Digital volt-ohm-meter
- *Calibrated general coverage receiver, 40M CW receiver, or frequency counter

Soldering is not hard if the proper procedure is followed. The soldering iron is to be used to heat up the PC pad and component lead, and the solder applied to the pad, where it melts and flows into the hole. Do not melt the solder onto the tip of the iron and then attempt to dab it onto the joint – a defective connection will result! After soldering, check the top (component side) of the board, to be sure the solder has filled the hole completely, and wicked up around the component lead. Re-heat and apply more solder if necessary.

Theory of Operation

The Bayou Jumper, like the Paraset that inspired its creation, utilizes very simple and robust circuitry to achieve reliable operation. Despite this simplicity, it attains the maximum of performance from its minimum number of components, in the true spirit of QRP.

The transmitter design of the Bayou Jumper is borrowed from the 4SQRP classic 'NS-40'. This design is a master-oscillator/power amplifier circuit, with high-efficiency spiral PCB coils serving as the transmitter's harmonic filter. The 2N7000 Master Oscillator, Q5, works against the gate capacitance of the IRF510 power amplifier, Q4, as an unusual inverted Colpitts oscillator. The power amplifier Q4 is tuned to operate in the Class E mode, generating 5 watts from 13.6 volts, at better than 85% efficiency. Closing the key contact energizes the source circuits of Q4 and Q5 via the P-Channel MOSFET keying transistor, Q7, permitting oscillation to commence. Q7 operates with an RC network to provide shaping of the keyed envelope. A built-in key is included in the design – just like in the original Paraset!

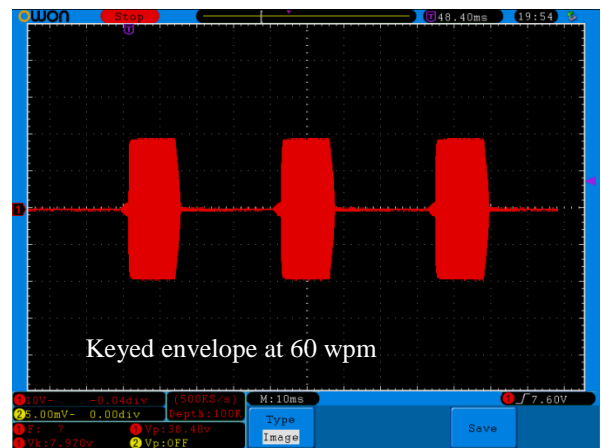

The MOSFET keying transistor, Q7, allows the revD Bayou Jumper to be used with almost any electronic keyer with no modifications, and without worry about the current handling capacity of the keyer's output stage.

The receiver is a simple regenerative circuit, based on the innovative designs of Charles Kitchin, N1TEV. Q2, a J-310 JFET, is a regenerative detector in an Armstrong circuit, with a 1N5819 diode acting as a varactor capacitor in the tickler throttle circuit. The regeneration control, potentiometer R10, varies the reverse bias voltage on the diode D2, changing its capacitance and varying the amount of feedback current it passes through the tickler feedback winding of L1.

The receiver frequency is tuned by also using a reverse biased diode as a varactor. The inductor L1 resonates against the sum capacitance of C20, (optionally C20a) C30, and diode D3. Tuning is performed by potentiometer R8, which varies the reverse bias voltage on D3, thus varying its capacitance.

The antenna is coupled to the detector through the grounded-base amplifier Q1, a 2N3904. This amplifier also isolates detector oscillations, preventing them from being radiated back through the antenna. An RF attenuator control, R1, can be used to reduce the amplitude of strong signals that might overload the receiver.

The detected audio appears at the source of the regenerative detector Q2, and is coupled through capacitor C5 to audio preamplifier Q3, a 2N3904. Its output is coupled to the volume control R6.

The output of the volume pot is amplified by the Audio Amplifier U1. This IC, an NJM2113 is a low-noise headphone driver amplifier. Its balanced output feeds the tip and ring contacts of the Headphone jack, J4. The shell contact is left floating, placing the two headphone elements in series. This amplifier is also capable of driving an external 8 ohm speaker.

A 6-volt regulator IC, U2, provides steady bias voltage to the low-level RF and audio circuitry of the receiver, eliminating any tendency toward audio howl or instability.

Switching between transmit and receive operation is performed with a rotary switch SW1. This disables the receiver during transmit, and switches the antenna between the transmitter and receiver sections. This switch also has an OFF position, switching the antenna input to ground as well.

Enclosure

It would be best to prepare the enclosure before beginning assembly of the PC boards, in case any minor sanding or filing were to be needed to refine the fit of the boards into the box. Do a “dry fit” to verify that the four wood posts are the proper length to allow the panel to be recessed slightly. There has been some variation in dimensions of the boxes, occasionally requiring some trimming.

The enclosure must be prepared to mount the circuit boards. Included in the kit are four 3/8” wooden blocks that must be glued into the four inside corners of the box. Use wood glue to attach them (Elmer’s Carpenter’s Wood Glue – the yellow kind). To allow the panel to be inset slightly, the posts should be spaced down from the rim of the box by the thickness of two PC boards (about 1/8”) – you can use the two crystal adapter boards as a thickness gauge.

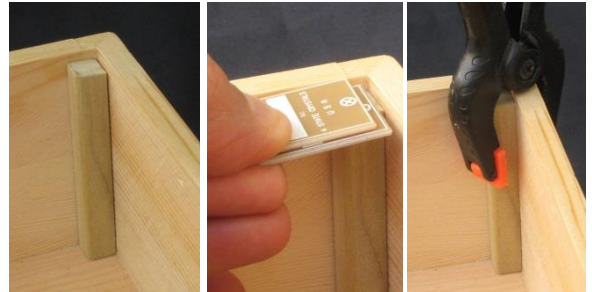

After the glue has dried for several hours, place the top panel circuit board onto the four corner blocks. Use a pencil to mark through the four corner holes in the top panel board onto the corner blocks. Remove the top panel.

There are four wood screws in the parts kit for mounting the circuit board assembly. If driven directly into the corner blocks, there is a risk the blocks will split, so it is necessary to drill pilot holes for the mounting screws. Use a 1/8” bit in a hand drill (or drill press if available), drill down approximately 1/2”.

Solder Filling Selected Vias

*Vias are small plated-through holes that electrically join the top and bottom copper layers of the circuit board. Inside the heavy traces to the right of D1 and below C22 you’ll see two groups of vias in the middle of those traces. These traces and vias carry the full transmitter current – hundreds of mA. To ensure a low resistance path these vias should be **filled**. Enough solder should be flowed into them so the solder is level with the via pads on both the top and bottom sides. The same should be done to the vias at the center of each of the etched inductors.*

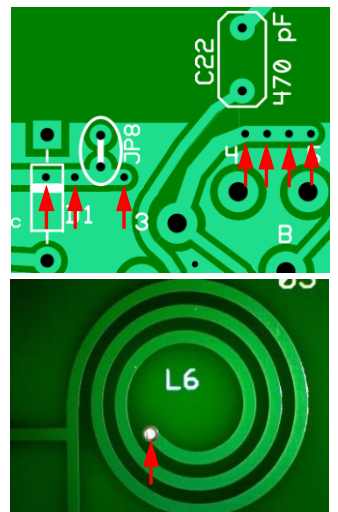

Fill the THREE vias in the heavy trace near D1 (red arrows)

*Note: **DO NOT** fill the two holes associated with jumper JP8. That jumper will be installed later.*

Fill the FOUR vias in the heavy trace near C22

Fill the THREE vias in the centers of the etched inductors L3, L5, and L6

Preliminary Assembly

The large components (four potentiometers, BNC jack, and rotary switch) will be installed first. In order to ensure that these components properly line up with the holes in the top panel, test fittings will be performed.

Locate the six 5/8" hex standoffs and twelve of the 6-32 x 3/8" machine screws. Use six of the screws to install standoffs on the bottom side of the **Top panel** circuit board (**NOT** the main circuit board) at the six perimeter mounting holes (**NOT** the four corner holes).

The first components to be installed on the **MAIN** circuit board will be the four potentiometers. R6, R8 and R10 are 50 k pots, marked "503" while R1 is a 5 k pot, marked "502." All four of these potentiometers will be installed "standing proud" to ensure that there is enough shaft above the panel to accept the knobs securely.

Note: A few builders have expressed a preference for having the main tuning dial indexed at the bottom, rather than at the top, of the dial. To accommodate this request there are two groups of pads provided for R8, the main tuning control. The group nearest jumper JP1 (indicated by the red arrows in the photo below) is normally used. However, if you wish to make use of the small index mark at the bottom of the tuning dial, use the alternate set of pads so that the span of the pot will match that index mark.

See **Appendix P** for details about required wire jumpers.

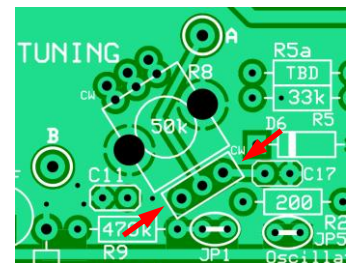

Place the main PC board flat, right side up, on a hard work surface, and insert the mounting tabs and pins of R8 (50 k, marked "503") through the PCB mounting holes so that the tips of the two tabs rest flush against the work surface without extending past the bottom of the board. This ensures that the pot shaft sits as high as possible.

Use the red-arrow-marked holes unless you chose otherwise.



Notice that when the two mounting tabs are flush with the bottom of the board, the three contact pins will not quite penetrate all the way to the bottom. This is normal and correct. The holes are through-plated, and when soldered the connections will be solid.

Make sure the pot shaft is vertical, and then solder only one of the mounting tabs to the board. It will be easiest to solder on the top side of the board.

Place the top panel, with its standoffs in position, atop the main PCB. Use three screws to temporarily secure the panel to the main board. Inspect the alignment of R8 and make sure that the shaft can turn easily without rubbing the sides of the hole. If needed, reheat the soldered tab and reposition the part.

Remove the top panel and set it aside for the moment. Do not yet solder the remaining tab and pins.

Repeat the above two steps for the other two 50 k pots, R10 and R6 (marked “B5 03”), and the 5 k pot, R1 (marked “B5 02”). Again, solder only one tab of each part at this time. Check the alignment of each one by temporarily replacing the top panel each time.

When all four potentiometers have been partially installed, replace the top panel. Secure it with all six screws, and make a final check of the alignment. When you are satisfied with the positioning, remove the top panel and solder the remaining tab as well as the three pins of each part.

Next the rotary switch and the BNC jack will be installed. Alignment of these parts will be much more straightforward, since they will be firmly seated against the PCB and should “auto align.”

*You may wish to read the section in **Appendix A** concerning shortening the shaft of the rotary switch. It's only for appearance sake, to allow the knob to nestle down close to the panel. If you decide to do this optional step, it is most easily accomplished before the switch is soldered to the board.*

(optional) The shaft of the rotary switch is too long to allow the selector knob to mount close enough to the panel. Trim a bit off, but be sure that there is least $\frac{1}{4}$ ” of the shaft remaining.

The plastic index post is not needed and will interfere with the top panel mounting. Nip it off with diagonal cutters.

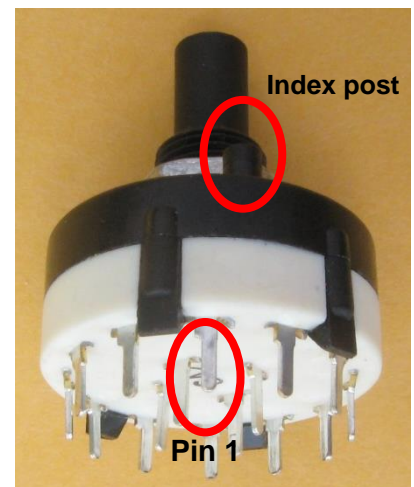

Install the rotary switch SW1. Be sure the nut on the bushing is snugged up against the toothed lock washer. Do not over tighten. Be certain that Pin 1 is inserted into the square pad marked “1”. The pin numbers are molded into the switch body. Make sure the switch is fully seated against the PCB and the shaft is vertical. Solder only one of the four inside pins at this time.

Install the BNC jack in its location at the upper left corner of the PCB. Be sure it is flat and flush against the board and is vertical. Solder only the center pin at this time.

Re-install the top panel and make another alignment check. Locate the “chicken head” pointer knob and install it on the rotary switch’s shaft. You’ll need a 1.5 mm Allen wrench to tighten the set screw. Check that the pointer will align with the panel markings for the three switch positions. If all is satisfactory, remove the knob and panel and set them aside. You may leave the standoffs in position if you wish.

Now solder all of the remaining pins of the BNC jack and rotary switch.

The leads of resistors and axial leaded inductors should be bent in a gentle radius about 0.1” from the body of the part, so that the component body is not stressed or broken. If you have a bending jig, use it, selecting 0.4” spacing for all ¼ W resistors and diodes, 0.5” for L4, and 0.6” for L2. The bodies of these components should rest flush against the board surface when mounted.

Inductors

There are two molded inductors that look a lot like resistors. Add these next. Be especially careful when bending the leads of these parts. Notice the relative sizes in the photo. The one with the larger inductance (L4 470µH) is the smaller physical size and may have either a brown or green body.



L4: 470 µH

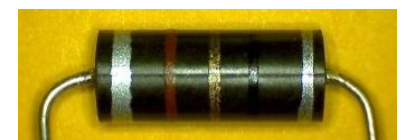

L2: 1 µH

√	Ref	Value	Marking	Description
	L2	1.0 µH	Silver-Brown-Gold-Black-Silver	Molded Axial Choke .6” LS
	L4	470 µH	Silver-Yellow-Violet-Brown-Silver	Molded Axial Choke .5” LS

*Special note for builders who intend to install a NAIMH Soup'er Up'er accessory board that is described in **Appendix J**.*

You may wish to just tack solder R9 and C9 to the board in the upcoming steps, leaving extra long lead lengths, since these parts will be subsequently removed after the basic checkout of the Bayou Jumper, prior to installation of the Soup'er Up'er. Leave enough lead that they can be easily nipped off and salvaged for the spare parts bin. Alternatively, you can just cut one lead of each part, separate the cut ends, and leave them in that state – in case you should ever wish to uninstall the Soup'er Up'er.

Resistors

Next, install these resistors, whose lead spacings may all be prepared as 0.4".

Save a few of the discarded leads for use as test points and jumpers later on.

√	Ref	Value	Marking	Description
	R16	100 Ω	Brown-black-brown	¼ W 5% axial
	R17	1.0 k	Brown-black-red	¼ W 5% axial
	R2	1.0 M	Brown-black-green	¼ W 5% axial
	R4	1.0 M	Brown-black-green	¼ W 5% axial
	R15	100 k	Brown-black-yellow	¼ W 5% axial
	R3	2.7 k	Red-violet-red	¼ W 5% axial
	R12	3.3 k	Orange-orange-red	¼ W or 1/8 W, 5% axial
	R7	3.3 k	Orange-orange-red	¼ W or 1/8 W, 5% axial
	R13	330 k	Orange-orange-yellow	¼ W 5% axial
	R5	33 k	Orange-orange-orange	¼ W 5% axial
	R11	470 k	Yellow-violet-yellow	¼ W 5% axial
	R9	470 k	Yellow-violet-yellow	¼ W 5% axial
	R14	470 k	Yellow-violet-yellow	¼ W 5% axial
	R18	470 k	Yellow-violet-yellow	¼ W 5% axial
	R21	4.7 k	Yellow-violet-red	¼ W 5% axial
	R22	10 k	Brown-black-orange	¼ W 5% axial

Semiconductors

Touch a grounded object before handling static sensitive parts. Be sure your soldering tools are grounded or are rated ESD safe

Identify and install the following diodes and transistors. Be certain that their polarity is correct, and that they match the board's silkscreened outlines.

It is not necessary to secure Q4 and Q6 to the PCB, but you may safely do so if you wish (4-40 machine screw & nut - hardware not supplied with kit).

A 4-40 x 1/2" screw and nut are supplied and should be used to secure Q7.

No insulating film is required beneath these parts.

√	Ref	Value	Description
	D1	1N5819	Schottky Diode (rectifier) <i>see note below</i>
	D2	1N5819	Schottky Diode (varactor)
	D3	1N5819	Schottky Diode (varactor) <i>May be installed on bottom side, see note at right</i>
	D5	1N914	Silicon Small-signal Diode
	Q1	2N3904	TO-92 NPN BJT rf amp
	Q3	2N3904	TO-92 NPN BJT af amp
	Q5	2N7000 <i>**Static** sensitive part</i>	TO-92 N-Channel Enhancement Mode MOSFET (oscillator)
	Q4	IRF510 <i>**Static** sensitive part</i>	TO-220 N-Channel Enhancement Mode Power MOSFET (PA)
	Q6	IRF510 <i>**Static** sensitive part</i>	TO-220 N-Channel Enhancement Mode Power MOSFET (polarity protection)
	Q7	IRF9640 <i>**Static** sensitive part</i>	TO-220 P-Channel Enhancement Mode Power MOSFET (keying) Use #4-40 x 1/2" screw and nut <u>NUT MUST BE ON TOP OF TAB</u> PC board is marked "IRF9Z24"
	Q2	J-310	TO-92 N-Channel JFET regen detector
	U1	NJM2113	DIP-8 Audio Amp Use supplied socket (note notch)
	U2	78L06	TO-92 6 Volt Positive Regulator

Some builders have found that installing C18 and D3, (and if needed, C31) on the bottom side of the circuit board helps to reduce thermal drift. To facilitate that choice, the locations of those components are marked on the top and the on the bottom sides with silk-screened labels. See APPENDIX R.

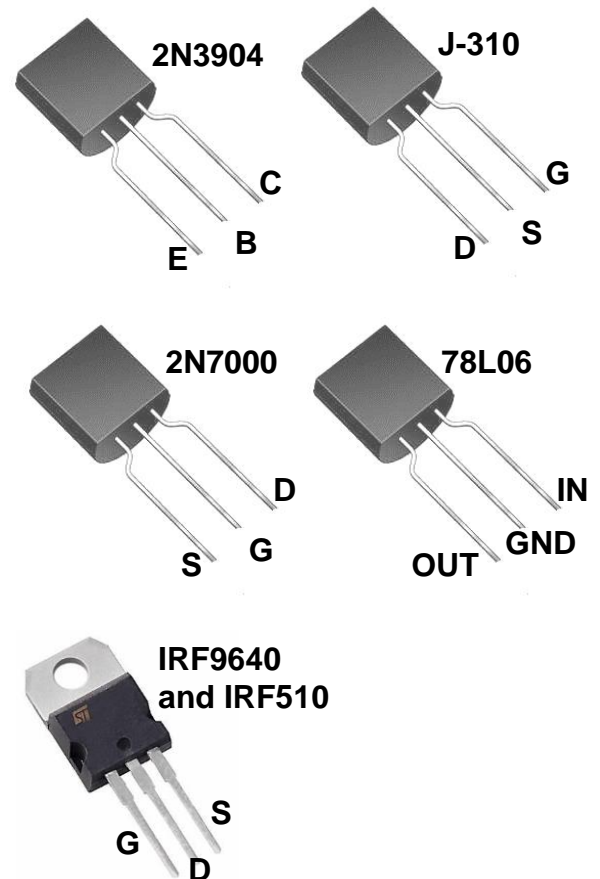

Note: The band on the silk screen outline for D1 may be partially obscured by several vias. The banded end of D1 should be oriented towards L6. You may wish to elevate the body of D1 very slightly above the board so that it is clear of those solder-filled vias.

Capacitors

The ceramic monolithic capacitors used throughout the kit are small and their markings not always easy to read. Use a magnifier to verify the values. Depending on part sources, the bodies may be blue or tan colored, but the most likely color is indicated. **MAKE SURE THAT THE 120 pF CAP GOES IN C20.**

Electrolytic capacitors must be installed with the correct polarity. The cases are marked to indicate the negative lead, which goes into the round pad on the board. The longer lead is positive, and goes into the square pad.

Install these capacitors, solder and trim the leads.

Do not install C31 or C20a at this time.

√	Ref	Value	Marking	Type
	C8	0.001 μ F	102	Dipped Monolithic Ceramic NP0, tan body, 0.2" lead spacing
	C14	0.001 μ F	102	Dipped Monolithic Ceramic NP0, tan body, 0.2" lead spacing
	C15	0.001 μ F	102	Dipped Monolithic Ceramic NP0, tan body, 0.2" lead spacing
	C28	0.0033 μ F	332	Dipped Monolithic Ceramic NP0, tan body, 0.2" lead spacing <i>re-form the leads to fit the PC board's 0.1" spaced pads</i>
	C1	0.01 μ F	103	Dipped Monolithic Ceramic, tan body, 0.1" lead spacing
	C2	0.01 μ F	103	Dipped Monolithic Ceramic, tan body, 0.1" lead spacing
	C11	0.01 μ F	103	Dipped Monolithic Ceramic, tan body, 0.1" lead spacing
	C17	0.01 μ F	103	Dipped Monolithic Ceramic, tan body, 0.1" lead spacing
	C24	0.033 μ F	333	Dipped Monolithic Ceramic, tan body, 0.2" lead spacing
	C5	0.1 μ F	104	Dipped Monolithic Ceramic, tan body, 0.1" lead spacing
	C7	0.1 μ F	104	Dipped Monolithic Ceramic, tan body, 0.1" lead spacing
	C19	0.1 μ F	104	Dipped Monolithic Ceramic, tan body, 0.1" lead spacing
	C25	0.1 μ F	104	Dipped Monolithic Ceramic, tan body, 0.1" lead spacing
	C27	0.1 μ F	104	Dipped Monolithic Ceramic, tan body, 0.1" lead spacing
	C29	0.1 μ F	104	Dipped Monolithic Ceramic, tan body, 0.1" lead spacing
	C32	0.1 μ F	104	Dipped Monolithic Ceramic, tan body, 0.1" lead spacing
	C34	0.1 μ F	104	Dipped Monolithic Ceramic, tan body, 0.1" lead spacing <i>Reform the leads to match the PC board's 0.2" spaced pads</i>
	C10	1.0 μ F	1 μ F	Aluminum Electrolytic, black, 0.1" lead spacing, observe polarity, longer lead is +
	C4	100 pF	101	Dipped Monolithic Ceramic NP0, tan body, 0.1" lead spacing
	C18	100 pF	101	Dipped Monolithic Ceramic NP0, tan body, 0.1" lead spacing <i>Optionally install on bottom side of PC board, see APPENDIX R</i>
	C26	100 pF	101	Dipped Monolithic Ceramic NP0, tan body, 0.1" lead spacing
	C20	120 pF	121	Dipped Monolithic Ceramic NP0, blue body, 0.1" lead spacing Reform the leads to match the 0.2" spaced pads
X	C20a	10 pF	10	Dipped Ceramic Monolithic NP0 <i>not supplied with kit, see page 23</i>

X	C31	22 pF	22J, 22, or 220	Dipped Monolithic Ceramic, tan body, 0.1" lead spacing DO NOT INSTALL YET
	C16	220 pF	221	Dipped Monolithic Ceramic NP0, blue body, 0.2" lead spacing
	C23	390 pF	391	Dipped Monolithic Ceramic NP0, blue body, 0.2" lead spacing
	C3	4.7 μ F	4.7 uF	Aluminum Electrolytic, blue, 0.1" lead spacing, observe polarity, longer lead is +
	C6	4.7 μ F	4.7 uF	Aluminum Electrolytic, blue, 0.1" lead spacing, observe polarity, longer lead is +
	C9	4.7 μ F	4.7 uF	Aluminum Electrolytic, blue, 0.1" lead spacing, observe polarity, longer lead is +
	C13	4.7 μ F	4.7 uF	Aluminum Electrolytic, blue, 0.1" lead spacing, observe polarity, longer lead is +
	C22	470 pF	471	Dipped Monolithic Ceramic NP0, tan body, 0.2" lead spacing
	C12	47 μ F	47 uF	Aluminum Electrolytic, black, 0.1" lead spacing, observe polarity, longer lead is +
X	C33	TBD	TBD	<i>Optional – not supplied with kit – see Appendix F</i>

Bottom Side Components

Read APPENDIX R and consider C30 options.

Install C21 and C30, the two pink trimmer capacitors (20 pF).

These mount on the bottom side of the board, soldered on the top side.

Notice the case of the trimmer has a flat side. Orient the flat sides to match the outline on the component silkscreen on the bottom of the board, as in the photo at right (yellow arrows). This ensures the adjusting screw is grounded, to minimize interaction with a metal adjustment tool.

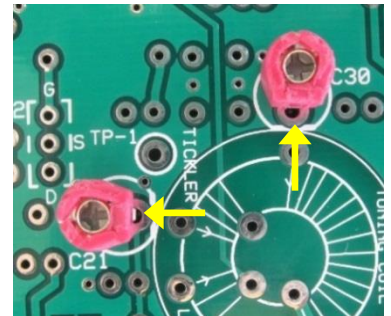

Preset both trimmers to maximum capacitance as shown in the photo at left (you'll need to use a magnifier). Your trimmer may have either of the "indicators" identified by the yellow arrows in the photo: an "arrowhead" as in the left hand image, or a slightly flared "tail" as in the right-hand one. In each case the trimmer is shown as being set to maximum capacitance.

√	Ref	Value	Description
	C21	4-20 pF	Trimmer Capacitor (pink or red)
	C30	4-20 pF	Trimmer Capacitor (pink or red)

Transformer

Next, wind the toroid L1. It contains three separate, independent windings.

During the alignment of the receiver, to set the tuning range and regeneration control span, you may need to squeeze together or spread out the turns of the main winding and/or the tickler winding.

*For this reason it is recommended that you install the toroid on the bottom side of the PCB. This allows adjustment of the trimmer capacitors and the toroid's winding's spacing without having to remove the top panel. The silkscreen outline is duplicated on the bottom to assist you. Performance of the receiver is not impacted whichever you choose. Do not be concerned that it appears the windings of a bottom mounted toroid are in the opposite directions. It is only the **relative direction** of the windings that matters. Notice that each winding has one turn that is labeled with an arrow. This is the end from which the winding begins, coming up from the PCB, passing over the top and down through the center of the core.*

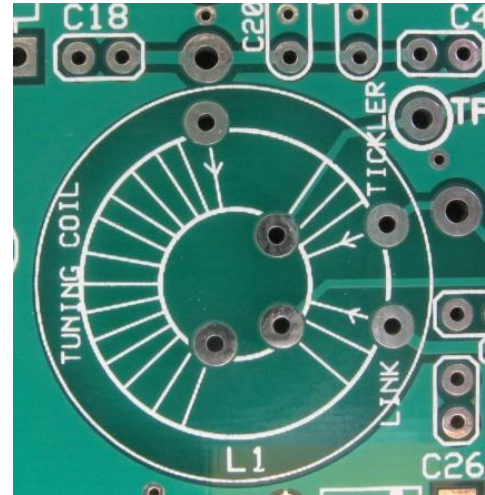

It is **essential** that this inductor be wound properly, with the correct number of turns, the proper winding direction, and location. By following the diagram on the PCB silkscreen successful construction can be assured. For additional help with winding, read the notes at <http://wa0itp.com/toroidophobia.html>

Once you have decided on which side to install the toroid, refer to the photos below as a guide to winding the turns in the correct directions. Don't worry if the numbers of turns in the photos below differ from these instructions – it's the direction that matters.

Note that the cores in the photos at right are yellow T68-6 cores, but you have been supplied with a white T68-7 core, which has a slightly better temperature coefficient.

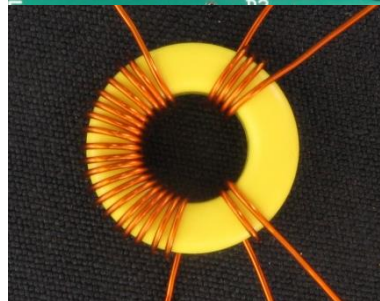
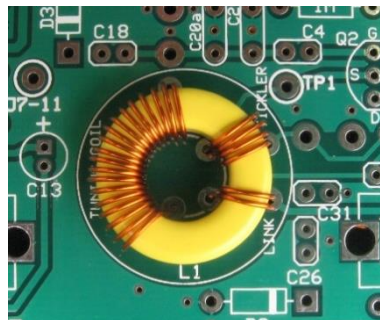

L1, shown wound for, and mounted on, the **top** side of the circuit board

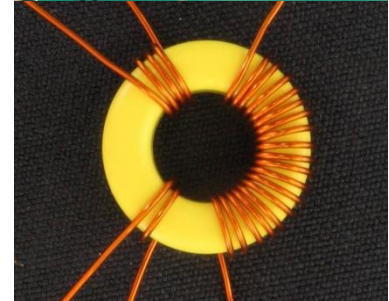
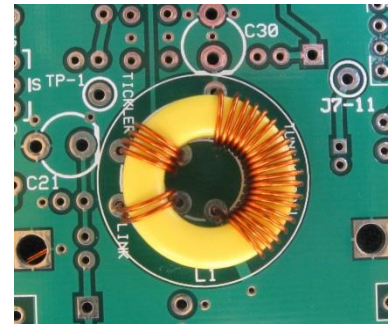

L1, shown wound for, and mounted on, the **bottom** side of the circuit board

There are several methods for stripping the insulation from magnet wire. The wire provided in the kit is thermally strippable. With a higher wattage or thermostatically controlled soldering iron, the heat (at least 750 degrees F) will be sufficient to strip the insulation from the wire. Alternately, insulation may be removed using sandpaper or a sharp hobby knife, prior to tinning.

Here's a tip you can try that may help ease the stripping/tinning process...

*Strip and tin about an inch at one end of your length of wire before you start winding. Use this tinned end as the starting end of the winding **on the inside of the toroid core**. The wire projecting from the inside of the core is always the hardest to strip and tin, because it must be done so close to the body of the core. Make sure that a tinned portion of the wire is flush with the bottom of the core so that it will make a good solder joint with the circuit board pad.*

By starting with a tinned section you'll now only have left to strip and tin that part that comes out over the top of the core – much easier to handle.

Locate the T68-7 (white) toroid core, and the #24 AWG magnet wire.

Wind the main tuning coil:

Wind **19 turns** (19 are pictured). If you make your windings nice and snug it should take no more than about 18" of wire. Remember: turns are counted as the number of times the wire passes through the center of the toroid. It is essential that the turns are pulled snugly around the toroid, so that there is no slack between the wire and core. When complete, cut the wire ends to about 3/4".

Next wind the tickler.

Using about 5" of wire, wind **4 turns** (4 pictured) of 24 AWG magnet wire for the tickler winding. Cut the wire ends to about 3/4".

Finally, wind the input link.

Using about 4" of wire, wind **2 turns** (2 pictured) of AWG 24. Cut the wire ends to about 3/4".

Strip and tin each of these wire ends prior to inserting into the PC board. Then pull the leads up snugly and solder them in place.

Test and Instrument Connection Points

Provisions are made on the PC board to install several wire loops that can be used to conveniently clip test instrument leads. There are three groups of five pads (the middle pad is not used). Two of the pad sets are grounded, and one set is connected to the +12 V supply. Each set is identified on the silkscreen legend. Use discarded resistor leads, forming them into loops. At each of the three groups of pads, install one loop on the top of the board and one loop on the bottom. Solder the top side loop on the bottom, and solder the bottom side loop on the top. *Be sure that the topside loop at the +12 V point will not be so tall as to interfere with the LED to be installed underneath the top panel.*

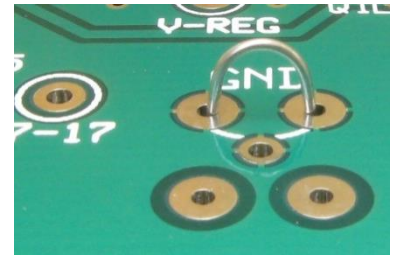

There are four places where single square post header pins are to be installed.

At the pads labelled **V-reg**, **GRN/RxVcc** and **RED**, insert the **short** end of a pin down through the top of the board and solder at the bottom. A bit of masking tape may help to keep the pin in position. They should look like the photo of J7-7 at right.

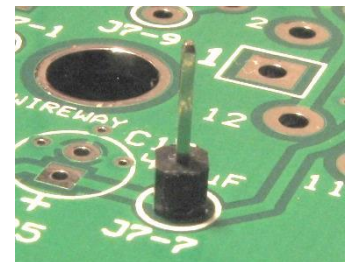

At pad **TP-1**, insert the **long** end through the board from the top, and solder on the bottom, as shown at right. This is done because this is just a test point, not a connection pin for plug-in wire, so a short test pin is OK, and it's accessible from the bottom too.

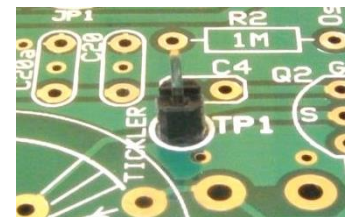

Wire Jumpers

Install wire jumpers on the top of the PC board at **JP1** (near R8), **JP4** (near R5), **JP5** (just right of **JP1**) and **JP6** (near U1). Form a loop in the same manner as the test points. Should you at a later date wish to open that jumper to install a modification, just cut the loop and slightly separate the conductors. **JP4** will be cut if a *Soup'er Up'per* accessory is later installed (**Appendix J**)

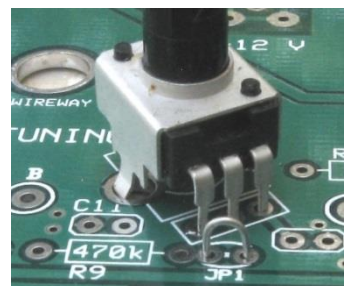

At this time, **DO NOT INSTALL** jumpers at **JP2**, **JP3**, **JP7**, and **JP8**. They are used for optional modifications which are explained in the **APPENDIX**.

Inspection prior to final assembly

Inspect the PC board closely for unsoldered connections, cold solder joints, solder balls or splatter, improperly installed or incorrect components. Make corrections as necessary.

Verify that there is **NOT YET** anything installed at these locations:
D6, C20a, C31, C33, R23, R24, JP2, JP3 JP7, JP8

The various J7-xx connection points are for use if a Soup'er Up'er Accessory is added later

Final Main Board Hardware

Add the contact post for the built-in key. This is a 3/8" hex standoff. Install using a 3/8" screw **with at least two flat washers between the standoff and the PCB**. Two extra washers are provided in case the key spacing needs to be adjusted to suit the builder.



Prepare the Molex® connector socket pin inserts to create the crystal sockets. Take each of the inserts, and, using diagonal cutters, snip off the bottom 'fishtail' as shown in the photos below.

Using fine-nose pliers or a crimping tool, gently squeeze the crimp area marked on the photo until the pins are a snug fit into the holes in the board for the crystal socket.

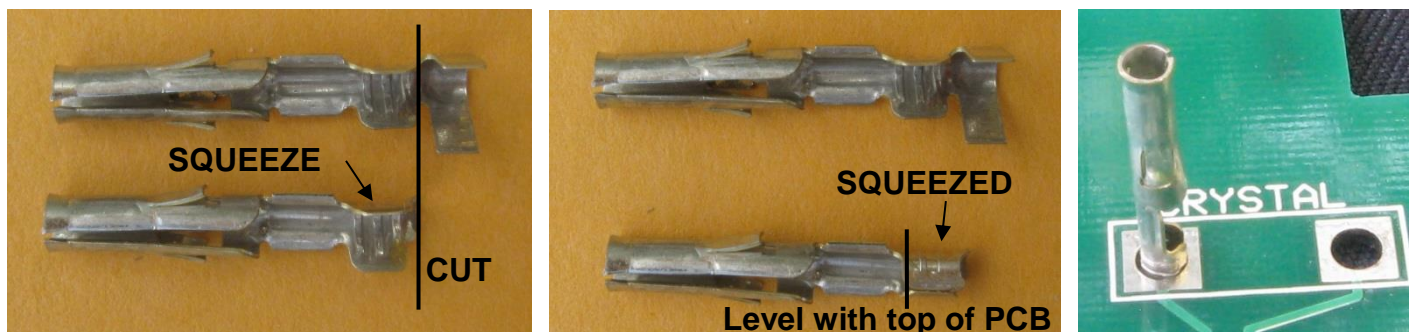

Make certain each pin is vertical before soldering, and adjust as necessary to correct any misalignment.

Top Panel Components

Assemble the built-in key. Locate the key leaf spring. This is a rectangular piece of 1/32" plated PCB with



three holes. Install two 6-32x 3/8" screws through the top of the panel. On the bottom of the panel, slip the leaf spring over these screws, and mount using two hex nuts on the bottom. Use a small drop of clear fingernail polish on the end of the screws to keep the nuts from working back loose.

Mount the key knob onto the leaf spring by inserting it through the top of the panel, and fixing it in place using the **8-32 brass** screw from beneath.

Prepare the power jack. Very gently bend the solder lugs of the power jack away from the body so that there will be clearance from the main board below. The lugs are brittle and fragile. The photo shows sufficient bend to clear the surface of the PC board below the jack. Strip 1/4" from the ends of the 3" red and black stranded wires. Solder the **red wire**

to the solder lug on the **center pin** of the power jack, and the **black wire** to the lug connecting to the **outer shell** of the jack. Use an ohmmeter if not sure which lug is which. Orient the lugs as shown in the photo and on the silk-screened labels on the board, to minimize the chance of an accidental short circuit.

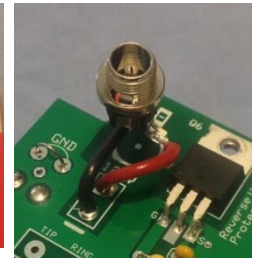

A matching power plug is supplied. Prepare that 12 V power plug with your choice of wire type and length so that 12 V can be applied to the circuit. A fused or current-limited supply is recommended, at least for initial testing. Your power source should be capable of supplying about 700 mA at between 12 to 14 V.

An addition to the revB, revC, and revD kits is a red/green LED pilot light and Tx/Rx indicator feature. This bi-color LED indicator can be treated as an option. If, after reviewing these instructions, you are uncomfortable assembling in this "Pittsburg style," you can just omit these steps. There will be no effect on the performance of the transceiver.

Mount the two resistors:

R19 (1 K, BRN BLK RED)
and R20 (2.2 K RED RED RED) on the underside of the top panel. These are installed "Pittsburg style" as shown in the photos. Bend the leads to form, then trim, them as in the photo at right.



Solder both resistors to their pads as shown in the bottom photo, below.

The LED has three leads. See the photo at right. The longest lead is the common cathode (negative). The next longest is the RED anode (positive), and the shortest is the GREEN anode.



Install the bi-color LED (D4), also on the underside of the top panel, again Pittsburg style.



The cathode lead will be soldered to the pad marked GND.
The RED anode lead should be soldered to the pad marked RED.
The GREEN anode lead should be soldered to the pad marked GREEN.

Be sure to carefully observe the polarity of the LED leads as shown in the photo. Grasp each lead with a long-nose plier close to the body of the LED and gently form and trim the leads as shown, so that the LED will be positioned over the tuning index marker. Solder the middle lead, then re-check the positioning before soldering the other two leads.

Locate the 12" jumper wire supplied in the kit – the one with a header socket at each end. Cut the wire in half, then strip about 1/8" of insulation from each cut end, and tin the exposed wires with solder.

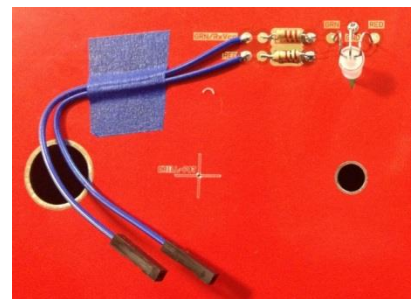

Solder one wire to the **GRN-RxVcc** pad on the underside of the top panel, and the other to the **RED** pad. It would be a good idea to use a bit of tape, or perhaps hot glue, to provide some strain relief for these wires.

When the front panel is mated to the main PC board the socket ends of these wires will be plugged into header pins on the main board:

The wire from pad **RED** will plug into pin **RED**.

The wire from pad **GRN-RxVcc** will plug into pin **GRN-RxVcc**

The ground (common) connection will be made via the standoffs that join the top panel to the main board.

The sockets on the ends of the two connecting wires are just a bit too tall to fit between the top panel and the main board when they are plugged into the header pins.

*To make room, remove the little plastic spacer on each of the pins **GRN-RxVcc** and **RED**. Just grasp the plastic spacer with your long nose pliers and pull straight up. The plastic part will slide off. The photos show how.*

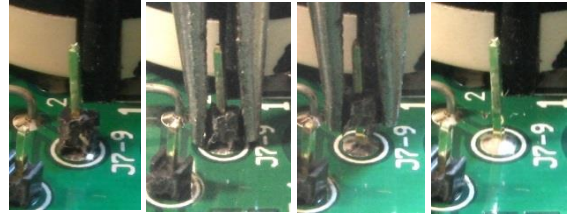

Here's how the bi-color LED indicator works:

When the transceiver is in Tx mode, 12 V is supplied to pin RED through SW1a. Pin RED is connected through R19 to the red anode of LED D4. Diode D1 serves to isolate pin RED from the 12 V supply. Therefore the red portion of D4 will be illuminated in Tx mode.

When the transceiver is in Rx mode, 12V is supplied to pin GRN-RxVcc directly through SW1a, and is also connected to pin RED through diode D1. Now 12 V is being supplied through R20 to the green anode of D4. So during Rx mode the GREEN portion of D4 will be illuminated, in addition to the red portion.

The green portion of D4 is more efficient than the red, and the human eye is more sensitive to the green portion of the visible spectrum, so the green light overpowers the red, and the indicator appears green. If R20 were to be increased to about 24K to reduce the intensity of the green, the green light would roughly balance the red and the colors would mix to appear yellow/amber.

Mating the top panel with the main PC board

Place the top panel (with the six standoffs attached) onto the main PC board. Secure it temporarily with two or three screws. Re-check the motion of the pots. If they do not turn freely, re-heat the mounting lug(s), and adjust the angle(s) slightly as needed.

Remove the top panel temporarily. The power jack, key jack, and headphone jack should still be mounted on the top panel.

Route the wires from the headphone and key jacks through the pad holes in the board as you bring the boards together. **Don't Solder Yet.** You may find the need to gently bend the **TIP** and **RING** lugs of the headphone jack outwards to ensure there is clearance between the lugs and the main circuit board.

Route the red wire from the power jack to the square '+12 V' pad on the PC board, and the black wire to the round '-' pad on the board. Also, plug in the two wires from the LED into the header pins marked **RED** and **GRN/RxVcc**.

Finish attaching the top panel using the rest of the six 6-32 x 3/8" screws. Gently pull the bus wires from the headphone and key jacks to take up any slack. Now you can solder them into place on the circuit board. Solder the two wires from the power jack as well. **Inspect the power jack lugs and wire leads to be sure there are no accidental short circuits.**

If the crystal pins are not centered under the top panel holes, re-heat the solder and reposition them. Push two plastic insulating sleeves into the crystal socket holes in the top panel, pressing them down over the crystal socket pins.

Install the five knobs. Be sure the round knobs are positioned so that the set screws bear upon the flatted portions of the shafts. The knob indicators should line up with the markings on the panel. The rotary switch has no flat. Adjust its knob so that it lines up with the three positions marked on the panel. See **Appendix C** for some additional comments about the main tuning knob.

Install the 1/2" male-female threaded

revised 18 May 2022

Bayou Jumper revD Assen

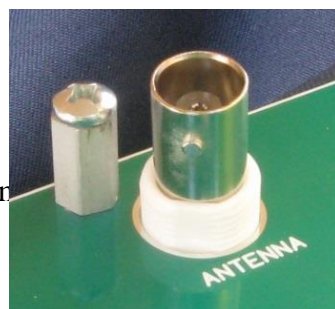

standoff on the top of the top panel near the BNC jack. The standoff replaces the supplied 3/8" 6-32 screw that is normally inserted there. Use the 3/16" 6-32 screw on top of the standoff so that the phillips screw head provides a "landing pad" for the crystal pin.

Should you need to separate the main board from the top panel for adjustments or troubleshooting, remove the nuts from the key, headphone, and power jacks, and remove the knobs. The crystal socket pins will slide out of the nylon insulators with some gentle pulling.

Crystal Adapters

The Bayou Jumper has a top panel crystal socket to fit FT-243 or FT-241A crystals, the old style Novice crystals that can still be found at hamfests. The kit includes two HC-49 packaged crystals, for 7.030 and 7.122 MHz. These are the two QRP *watering hole* frequencies where much of the QRP activity takes place. Also included are two adapter boards that you can use to build your own FT-243-compatible crystals. If your adapters look different from the ones in the photo below, see **Appendix H** for additional information.

Assembly of the crystal adapters is pretty straightforward. Trim the leads of the HC-49 crystals and bend them so the body of the crystal sits flat on the board. Solder them down to the two round pads. Cut two lengths of #10 bus wire about 5/8" long, and solder down to the two rectangular pads. Check the spacing against the crystal socket on the PCB. Using a fine file or emery board, taper the ends of the #10 wires so they insert into the sockets smoothly.

As a more elegant alternative to the #10 solid wire, you can obtain 3/32" brass tubing or rod at Hobby Lobby or other hobby or hardware stores.

If the builder has any of the old style FT-243 or FT-241A crystal holders, the miniature HC-49 size crystals can be mounted inside the cases for a truly vintage appearance! Some builders have 3-D printed vintage-look crystal holders.

To mount the "tall" HC-49U crystals in an FT-243 case may require some hollowing out to create enough space. They will fit very nicely in an FT-241A case, needing nothing more than perhaps filing down the contact posts slightly.

HC-49S crystals, the “low profile” ones, will fit either case with no modification.

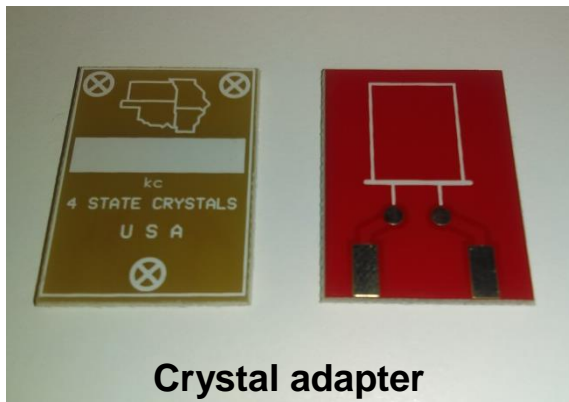

Receiver Tuning Setup

With all board-mount components installed, the next step is to set up the receiver for the desired tuning range, and the regeneration control for the proper range. A calibrated CW receiver or a calibrated 40 m signal source is needed, or use the Bayou Jumper’s spotting function to calibrate the receiver.

Connect the 12 V power plug cable to a regulated 12 V supply or battery. A fused or current limited supply is recommended, at least for initial testing. Insert the plug into the 12 V power jack. With the radio OFF it will draw a few μA from the supply through the ESD protection circuit, when ON and in RECEIVE it will draw around 25 mA.

Appendix M lists some expected values of supply current and RF output.

Be sure to read **Appendix L** before connecting anything other than a standard set of stereo headphones or an unpowered speaker to the PHONES jack. The audio output amplifier IC chip will be damaged by improper connections.

Plug headphones or unpowered computer speakers into the PHONES jack of the Bayou Jumper. The isolated stereo jack is wired to place the left and right earpieces in series.

Turn the Bayou Jumper power switch to the RECEIVE position. Turn the ATTEN, and REGEN controls to their fully clockwise positions, the VOLUME to about mid-scale, and the TUNE control to the lowest frequency position (fully counter-clockwise). You should hear a hiss in the headphones, indicating that the receiver audio is operating.

If you have a frequency counter or oscilloscope with a high-impedance probe, you may sample the oscillator frequency at the test point labeled TP1 on the back side of the board.

Otherwise, if you have a calibrated CW or shortwave receiver, turn it on, and make sure it is in the CW mode. Place the Bayou Jumper next to it. Sweep the receiver tuning from roughly 6.0 MHz to 8.0 MHz. Somewhere within that range you should hear the oscillations of the regenerative detector, which initially will probably be below 7 MHz.

Alternately, if a calibrated receiver is not accessible, a signal generator may be used to provide a calibration signal. Popular ham test equipment such as the MFJ antenna analyzers or the NanoVNA units can be used as signal generators. Connect a short piece of wire to the output of the generator to act as a small antenna, and place the Bayou jumper nearby. There is no need to make an electrical connection to the Bayou Jumper's antenna jack.

Turn the REGEN control fully clockwise, and set the VOLUME control for normal level. Set the Bayou Jumper's main tuning to mid-scale, then slowly sweep the generator from around 6 MHz to around 8 MHz. Somewhere in that range you should hear a signal.

If no signals are heard, the regenerative detector may not be oscillating. Jump ahead to the **Regeneration Setup** section to adjust the regeneration range.

If the frequency of the Bayou Jumper regenerative oscillator is not "close enough," you may use the trimmer capacitor C30 to adjust the frequency of the oscillation. Using a fine jeweler's screwdriver, rotate the trimmer capacitor setting approximately 1/8 of a turn at a time until the desired frequency is set.

If the trimmer capacitor C30 has insufficient range (it can shift the tuning range by a bit more than 200 kHz), you may squeeze together the turns of the toroid transformer L1 to lower the oscillation frequency, or spread them further apart to increase the frequency, then use C30 for final adjustments.

If the tuning range is still not satisfactory using both C30 and by adjusting the turns spacing of L1, your course of action will depend on whether the frequency range is too low or too high.

Should you need to separate the top panel from the main circuit board, remove the mounting nuts from the POWER, PHONE and KEY jacks. The top panel can

be removed without having to de-solder anything.

If the tuning range is too low – below the 7000-7150 kHz range – and you have spread out the turns of the 19 turn winding as far as possible, you will need to remove a turn from that winding. Just cut the wire where it emerges from the PCB on the outside of the core and pull the wire out from under the core to remove one turn. Use a solder sucker or solder wick to clean out the hole, and feed the wire back through to gauge its new length. Pull it back out to strip and tin the end then re-insert, snug it up, and solder in place.

If the tuning range is too high – and you have squeezed the 19 turn winding as tightly as possible there are two possible actions, *to be taken only after you have verified that C4 and C20 have not been accidentally swapped.* C20 should be 120 pF (marked “121”)

1) Add some additional capacitance to the tank circuit by installing an additional capacitor at C20a. A 10 pF NP0/COG capacitor (not supplied with the kit) would be a good starting choice.

2) Or, you may add a turn to the main winding of L1. This probably requires completely removing the toroid – though, with care, you could re-wind 20 turns while the core is still attached by the other two windings.

Adding more capacitance will have the additional effect of slightly reducing the width of the tuning range, while adding inductance (extra turn) has the opposite effect. The tuning range in either case should still be more than adequate to cover the portions of the band needed.

Once one of these processes has been done, repeat the calibration steps to set the range of the tuning control.

Regeneration Setup

The next step in receiver setup is to adjust the regeneration control range. Check out the MP3 audio clips posted in the Files area of the Bayou Jumper Group <<https://4sqrp.groups.io/g/BayouJumperKit>> if you are unfamiliar with how a regen receiver should sound.

Set the TUNING control to the middle of its range, the VOLUME control to mid-range, and listen to the headphone audio. It may help if an antenna is connected to the Bayou Jumper. Rotate the REGEN control knob from maximum to minimum, and back. You should notice a marked change in the

audio hiss in the headphones at some point along the knob travel, as the detector JFET Q2 enters and exits oscillation. This should occur near the midpoint of its travel. If this is not the case there are two likely scenarios:

(1) If there is no change to the hiss while adjusting the REGEN control, it means that the regeneration must be adjusted to either increase or decrease the amount of RF feedback in this circuit. If, for any setting of the REGEN control, you can hear the heterodyne of the Bayou Jumper's regenerative oscillator in your separate calibrated receiver, or hear the signal of a nearby CW transmitter or signal generator, then you have too much regenerative feedback.

(2) If no signals are heard, or the detector oscillations cannot be found in the test receiver, then the detector may not be oscillating because there is too little feedback through the tickler winding.

In either case (1) or (2) above, the first step is to adjust trimmer capacitor C21, next is to squeeze or spread the 4 turns of the tickler winding, and as a last resort, adding or removing a turn from the tickler winding. It is very unlikely that the tickler should have to be re-wound.

Adjusting the tickler winding and trimmer capacitor C21

Set the regeneration control, R10, about 30% of its clockwise travel. Set the main tuning to the low frequency end of the tuning range. Try to set C21 so that oscillation just begins (as evidenced by the increase in hiss in the audio) then back off C21 until the detector just barely drops out of oscillation. At this point the regeneration control, R10, should be able to bring the detector smoothly in and out of oscillation near the 30% - 50% point of its travel.

If it does not appear that the detector oscillates for any setting of C21, try squeezing the 4 turns of the tickler winding more tightly together. If still no oscillations, or oscillation only starts near the extreme CW rotation of the control, install the optional ceramic capacitor C31 (22 pF) and repeat the above procedure.

Conversely, if the detector always oscillates, no matter the setting of C21 or R10, be sure that C31 is NOT installed, and spread out the turns of the tickler winding. If that does not allow the detector to cease oscillating, decrease the value of C26. A good first try would be 82 pF followed by 75 pF.

If, on the other hand, you are not hearing any oscillations in your separate CW receiver, or hearing any CW notes in your Bayou Jumper Receiver when connected to an antenna, then you have insufficient regenerative feedback. In this case, install C31, the 22p capacitor, and re-test.

Re-check the receiver calibration. It's a good idea to do a final check with the radio installed into its box, but before screwing down the panel.

When the receiver calibration is satisfactory, you may fix the turns in place by painting the toroid with a light coating of clear fingernail polish. But this is not necessary if the windings have been made nice and snug.

Finally, secure the panel to the box's wood posts with the four #6 sheet metal screws. Be careful not to overtighten them, which could strip the threads you're cutting into the pre-drilled wood posts.

Operating the Radio

Operation of the Bayou Jumper is fairly straightforward. Make sure you are operating into an antenna with good VSWR – 1.5:1 or better. The transmitter in the Bayou Jumper is not overly sensitive to VSWR, but it has no built-in protection against very mismatched loads that could cause damage. It is best to use a tuner with a resistive-bridge type VSWR sensor, such as the 4SQRP 4S-Tuner.

Make sure there is a crystal inserted into the socket before transmission. Turn on the receiver and verify that you hear signals.

See **Appendix G** for methods of spotting the crystal frequency in the receiver.

With the REGEN, ATTEN, and VOLUME controls in their normal positions, you will likely hear signals. You can either call CQ or reply to a call as you would with any other rig – just be aware that you cannot change the transmit frequency without changing crystals! If you plan to work other Bayou Jumpers, be sure to tune around a bit after calling CQ – just like back in pioneer times!

Once you have your Bayou Jumper built and working, apply for a Secret Agent Number and get a matching serial number decal for your radio. See the Bayou Jumper web page, in the documentation area, for details:

<http://www.4sqrp.com/bayoujumper.php>



Troubleshooting

It will probably be best to un-mate the main and top panel boards to allow easy access for testing and troubleshooting. Remove the knobs and connector retaining nuts. Remember that the LED indicator will not work unless its wire leads are plugged in and a ground path exists between the main and top panel boards.

If your Bayou Jumper does not operate after assembly, repeat the visual inspection of solder joints. Especially inspect the leads of L1 for good solder connections. Compare the component placement diagram with the instructions to be certain that all components were installed in their correct locations. In particular, be sure that C20 and C4 have not been interchanged, which would make to tuning range too high in the band. C20 should be 120 pF and C4 should be 100 pF.

A check of voltages at strategic locations on the board while under power can serve to isolate problems to a particular circuit. The table on the next page lists nominal voltages for the unit in receive and with the regeneration control fully counterclockwise.

If an entry is marked 'XXX' do not attempt to measure it.

The XXX voltages are at high impedance RF points where a DC reading will possibly be erroneous due to the high RF voltage present, or the stray capacitance of the voltmeter probe could cause the circuit to misbehave.

For those who may be experiencing the charm of a regenerative receiver for the first time, there are a series of MP3 audio files posted in the Files area at: <https://4sgrp.groups.io/g/BayouJumperKit>, the Bayou Jumper Kit Support Group. These give examples of what the receiver should sound like under various tuning conditions. The file names explain to what you are listening.

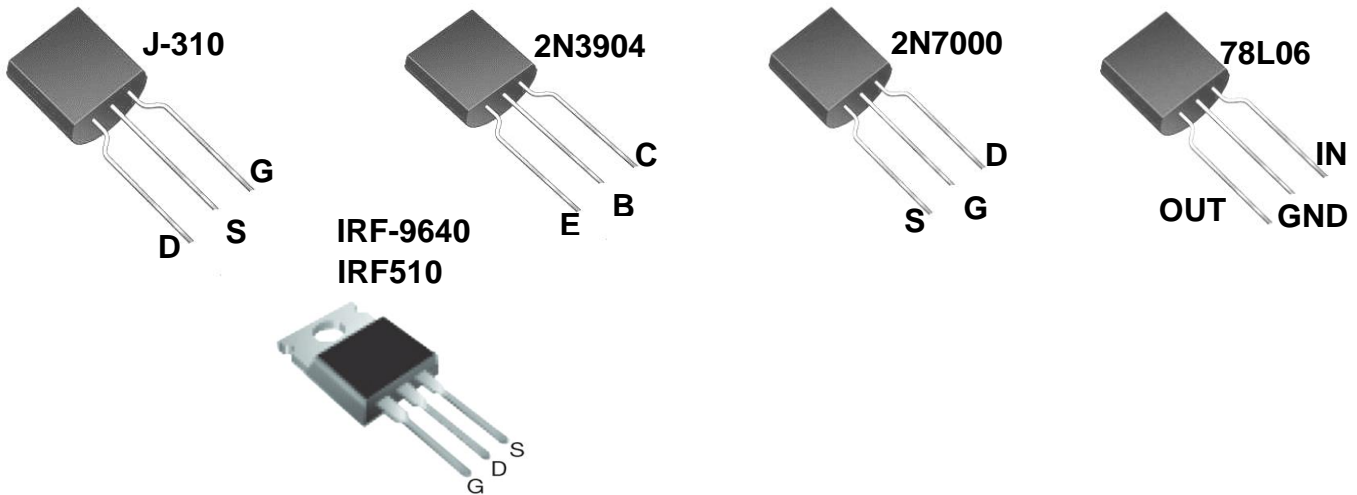

Voltage Chart -- values are approximate, based on a 12.0 V power supply
 Unless otherwise noted, mode switch is in RECEIVE position

Component ID	Pin	Expected V	Measured V
Q1	E	5.4	
	B	~6	
	C	~6	
Q2	G	0	
	D	1.5 to 3.5 V	
	S	~6	
Q3	E	0	
	B	0.65	
	C	between 2 & 4	

Q4 (in TX mode)	G	Key up: ~0 Key down: xxx	
	D	Key up: <20mV Key down: 10.4V	
	S	Key up: <20mV Key down: 10.4V	
Q5 (in TX mode)	G	xxx	
	D	Key up: <20mV Key down: 11V	
	S	Key up:<20 mV Key down:<20mV	
Q6	G	~12	
	D	0	
	S	0	
Q7 (in TX mode)	D	Key up: <10 mV Key down: 11V	
	S	Key up: ~12V Key down: 11V	
	G	Key up: ~12V Key down: <10mV	
U1	1 (square pad)	0	
	2 Vref	5.7	
	3 +IN	5.7	
	4 -IN	5.7	
	5 OUT1	5.7	
	6 Vcc	~12	
	7 GND	0	
	8 OUT2	5.7	
U2	1 (OUT) nearest C2	6	
	2 (GND) middle	0	
	3 (IN) nearest C25	~12	
R8	WIPER (middle) PIN	2 to 6 V as R8 is varied	
R10	WIPER (middle) PIN	0 to 6 V as R10 is varied	

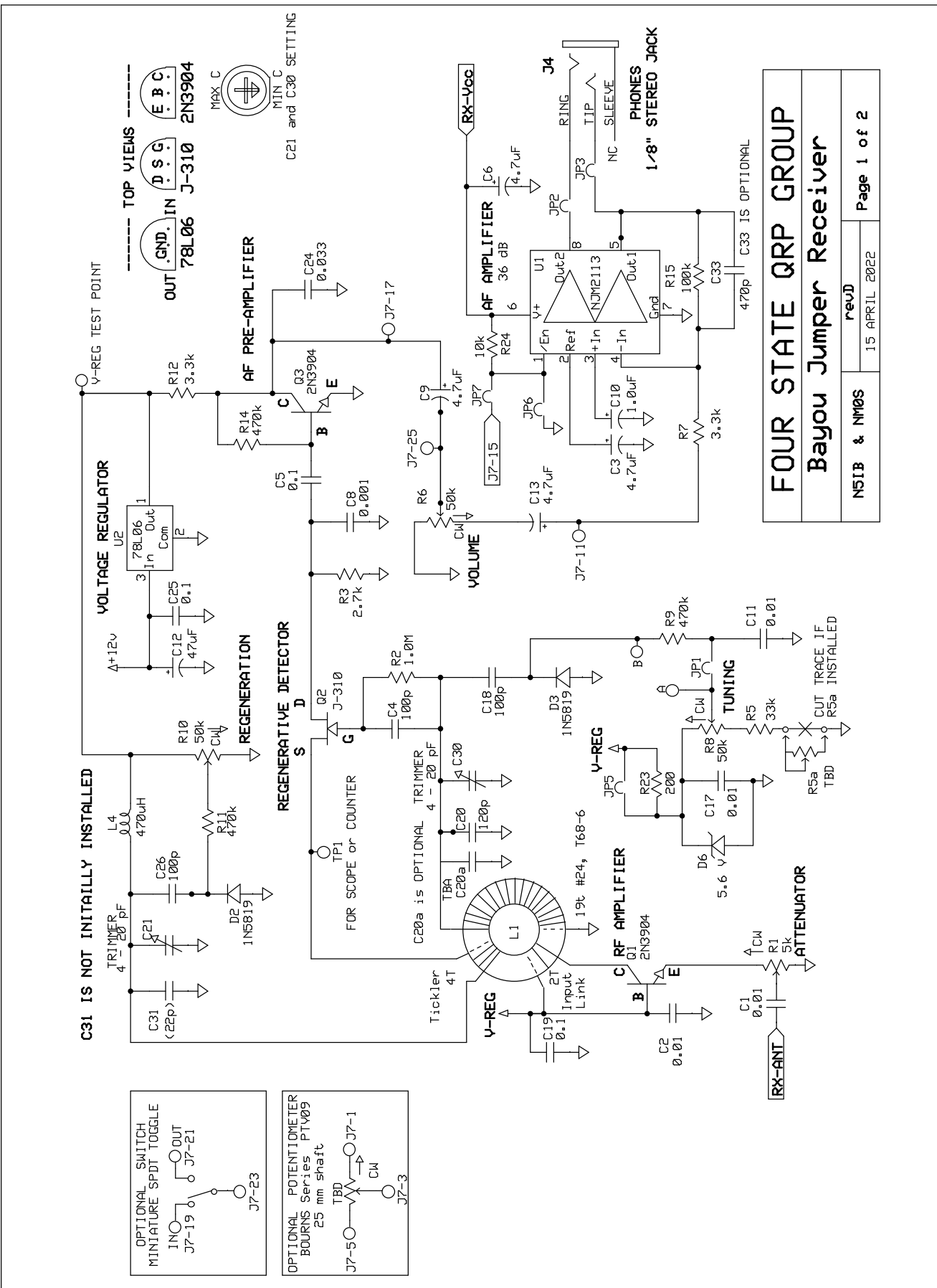

FOUR STATE QRP GROUP
Bayou Jumper Receiver
 N51B & N1M0S revD 15 APRIL 2022 Page 1 of 2

Four State QRP Group
BAYOU JUMPER revD
3 MARCH 2022
NM0S/N51B

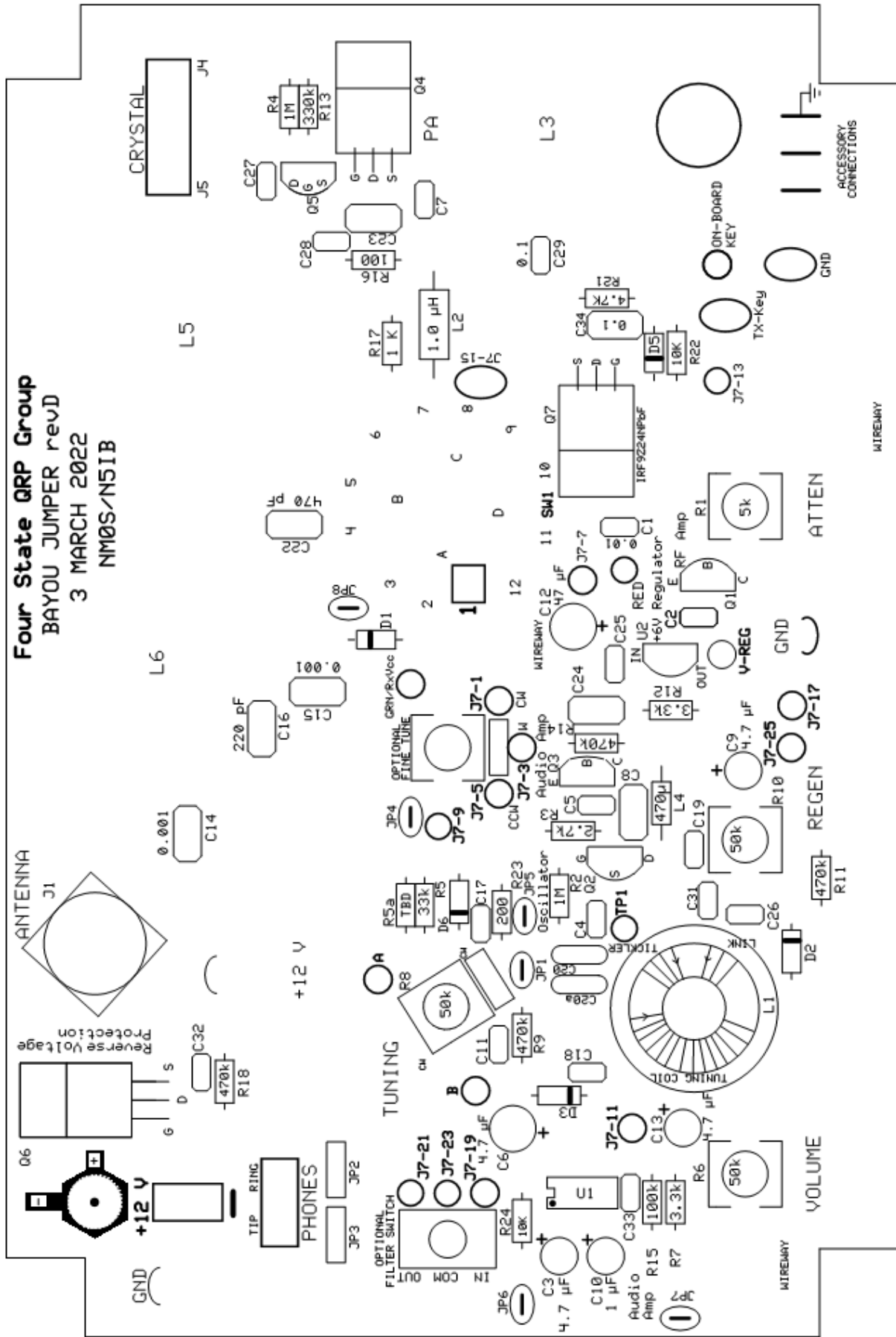

Top copper pattern and silkscreen, viewed from top side

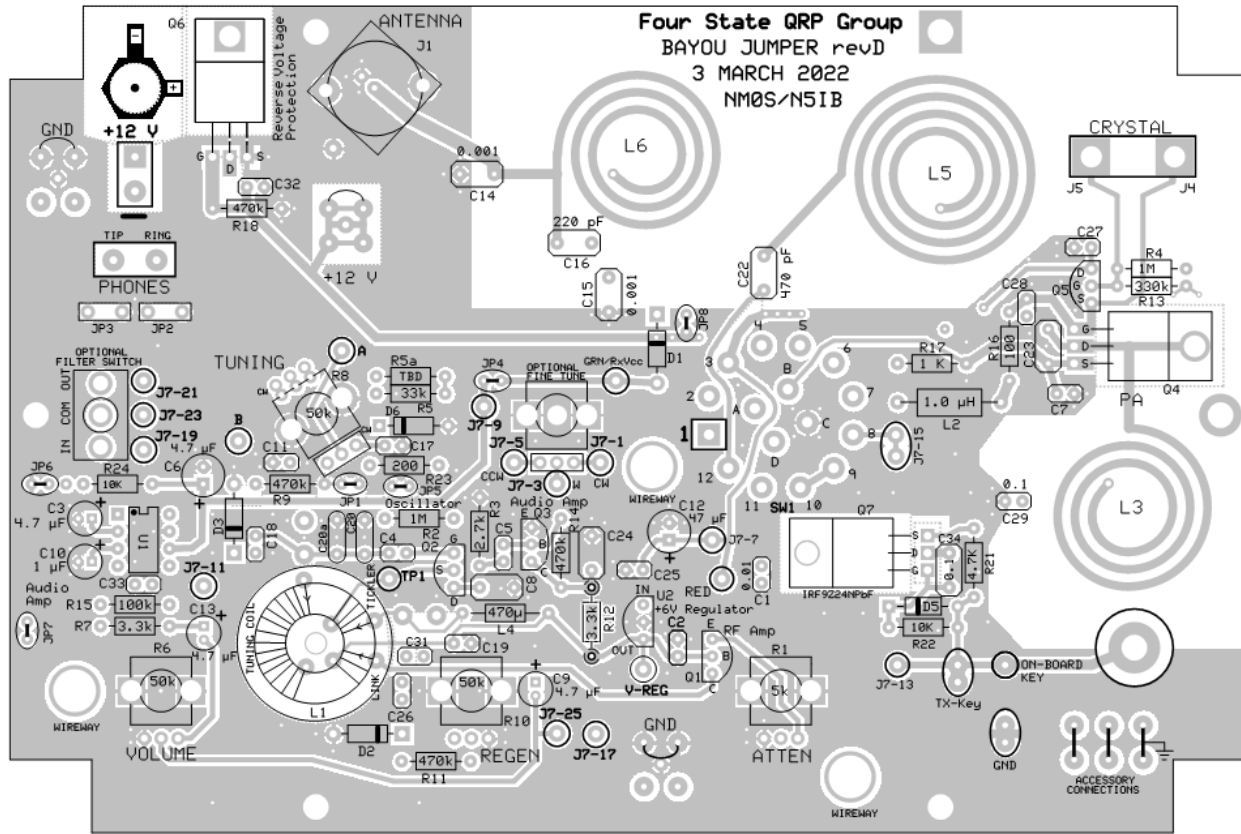

Bottom copper pattern and silkscreen, viewed from bottom side

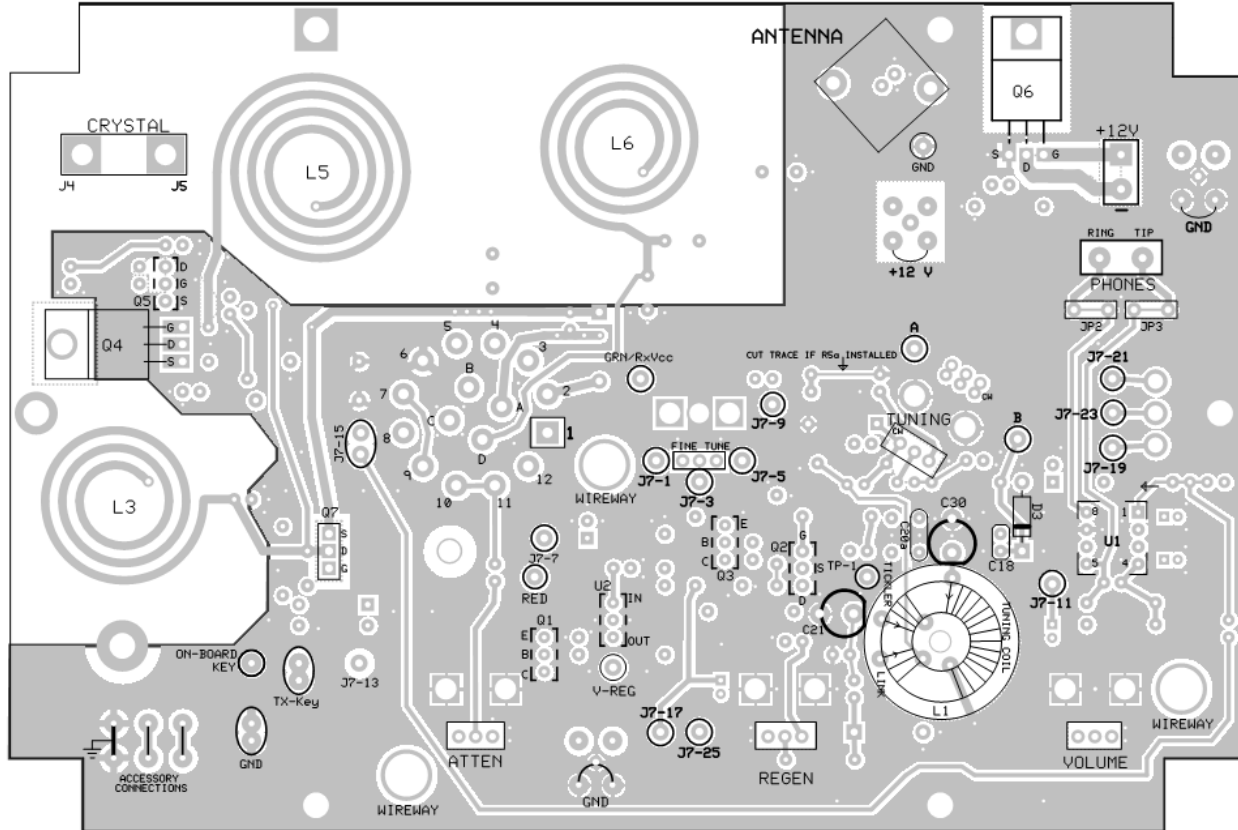

Top panel copper patterns and silkscreens, top and bottom views

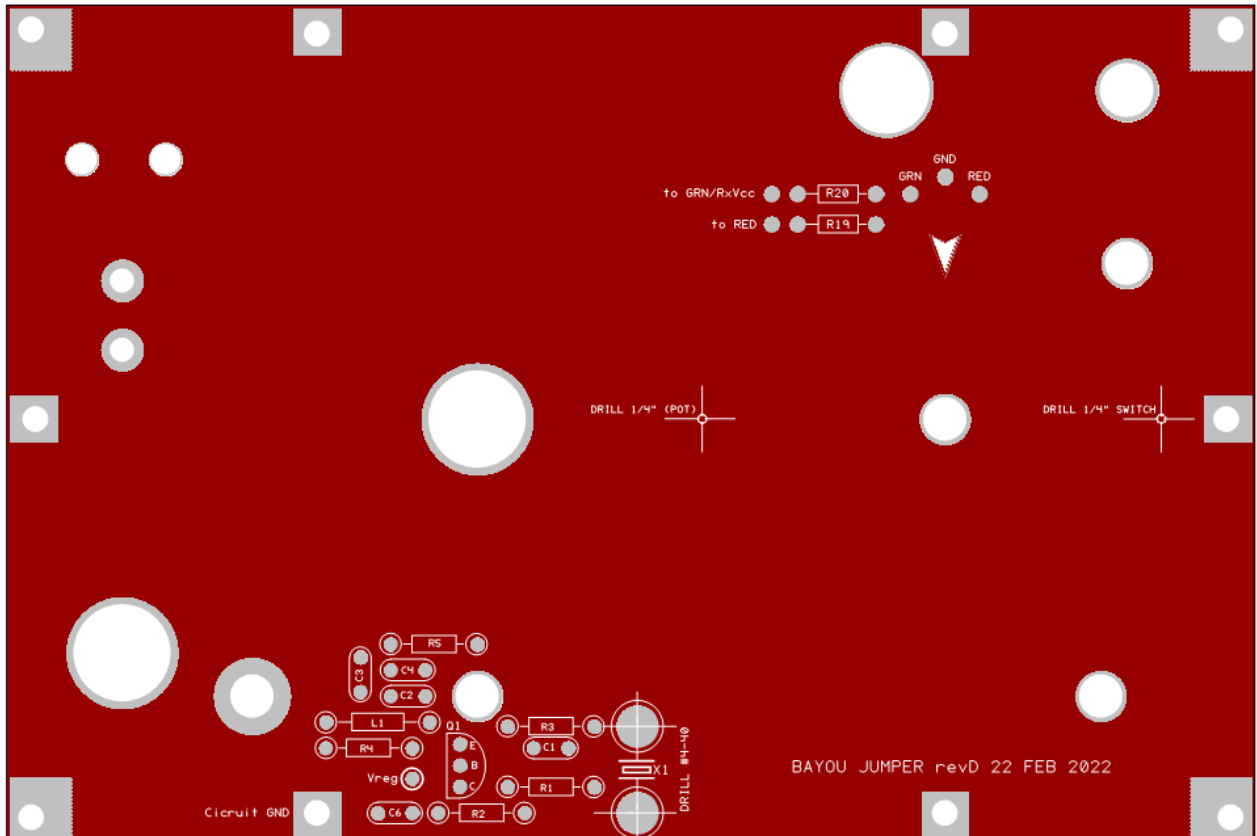
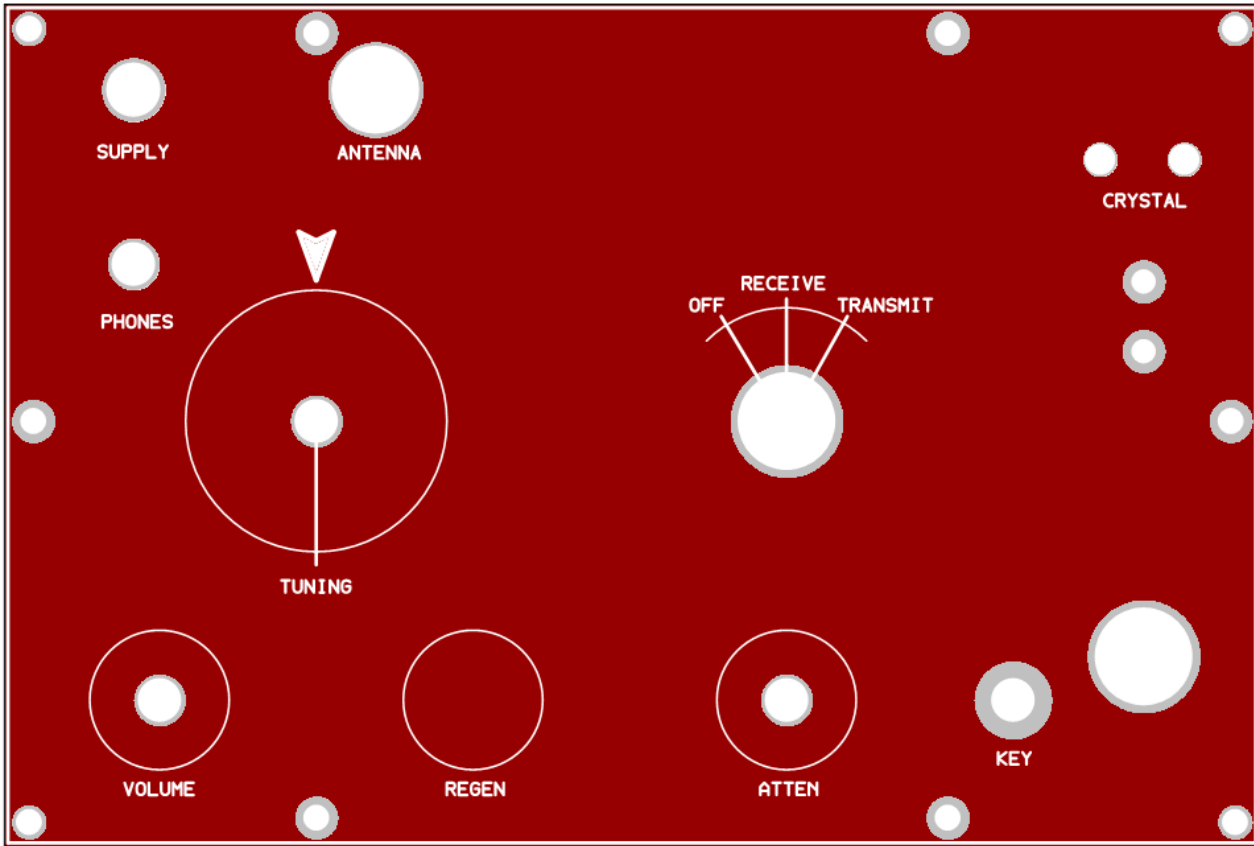

Top: Populated PCB, top view, note that the nut securing Q7 is on TOP
 Bottom: Populated PCB, bottom view, with toroid (white T68-7) mounted on bottom, along with C21, C30, D3 and C18

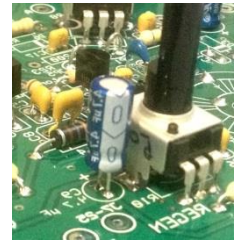
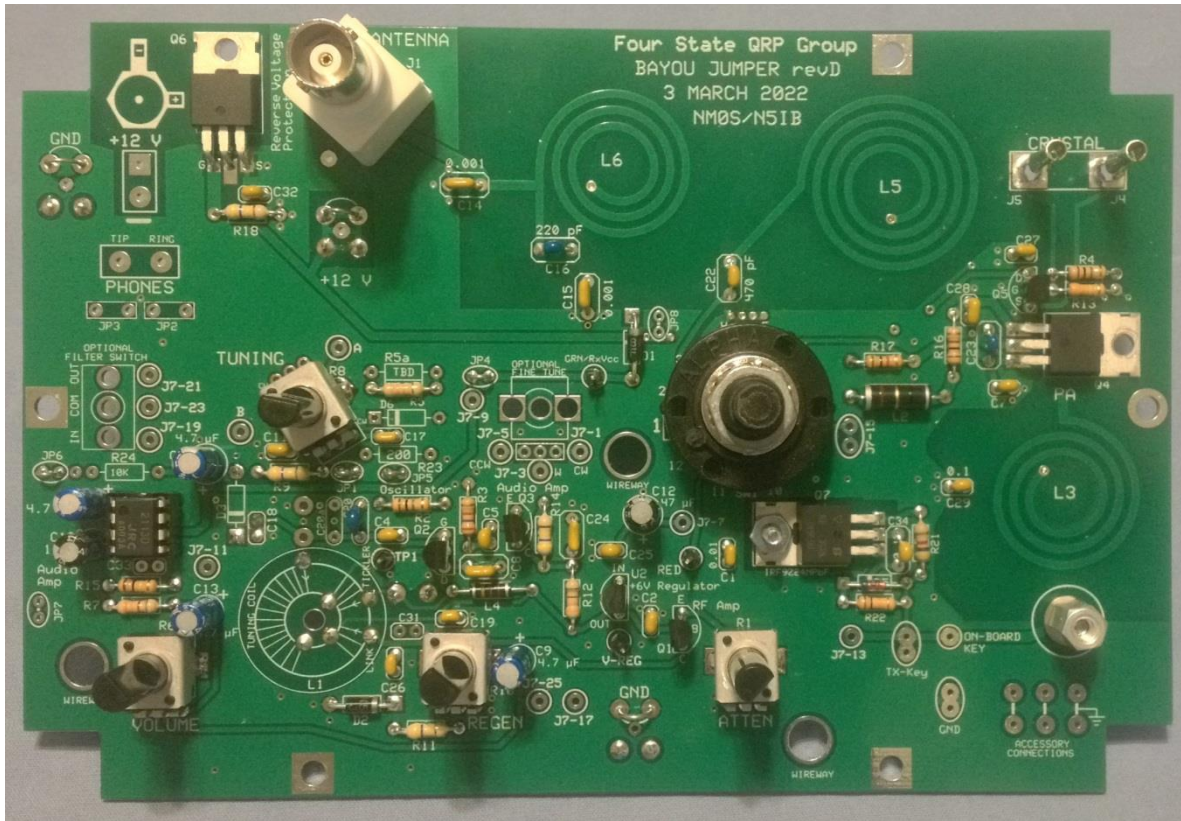

Note that C9 is installed with slightly longer leads, to allow easy removal if the Soup'er Up'er accessory is added.

Be sure the nut securing Q7 to the PC board is on top of the tab.

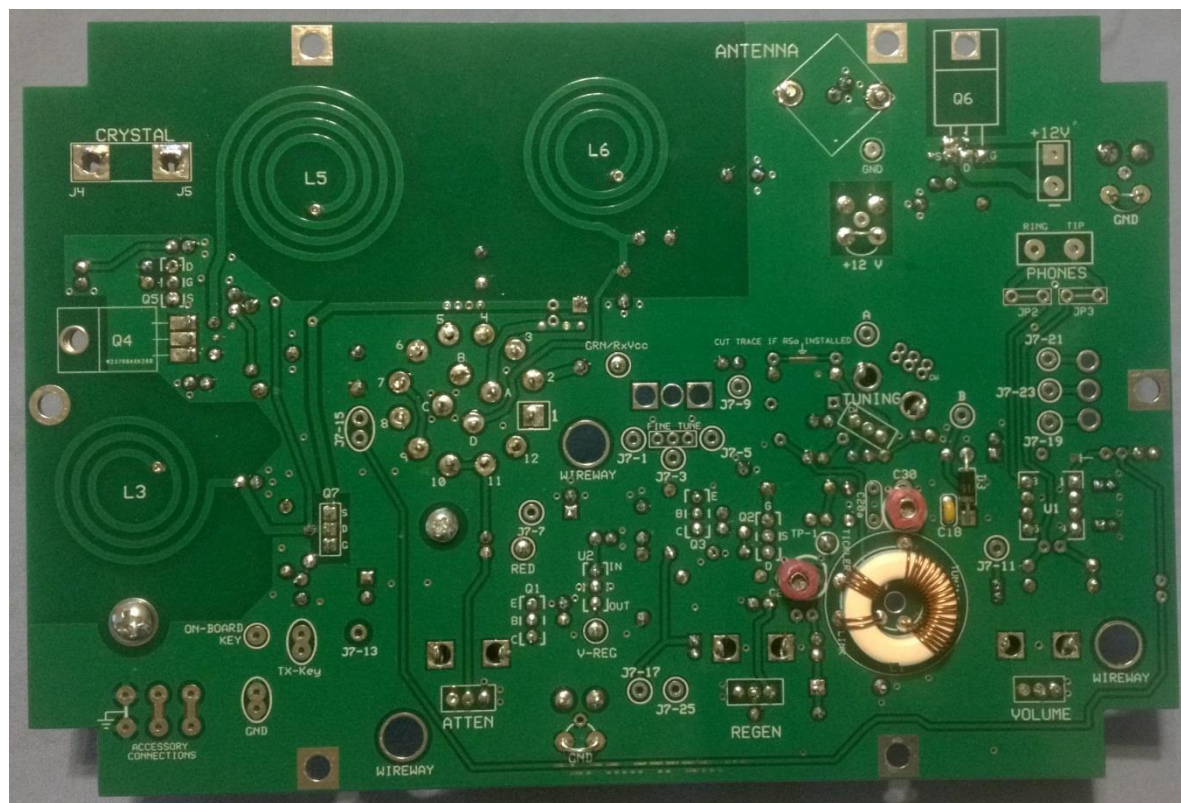

Here D3 and C18 are shown installed on the bottom side

Bottom and top of top panel, showing standoffs, LED connections, and crystal spotter circuit

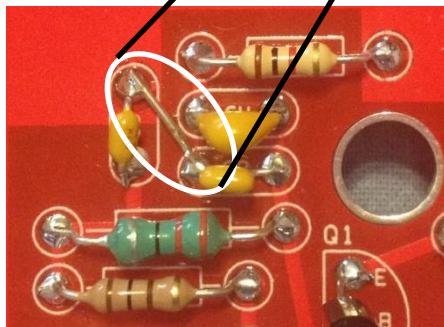
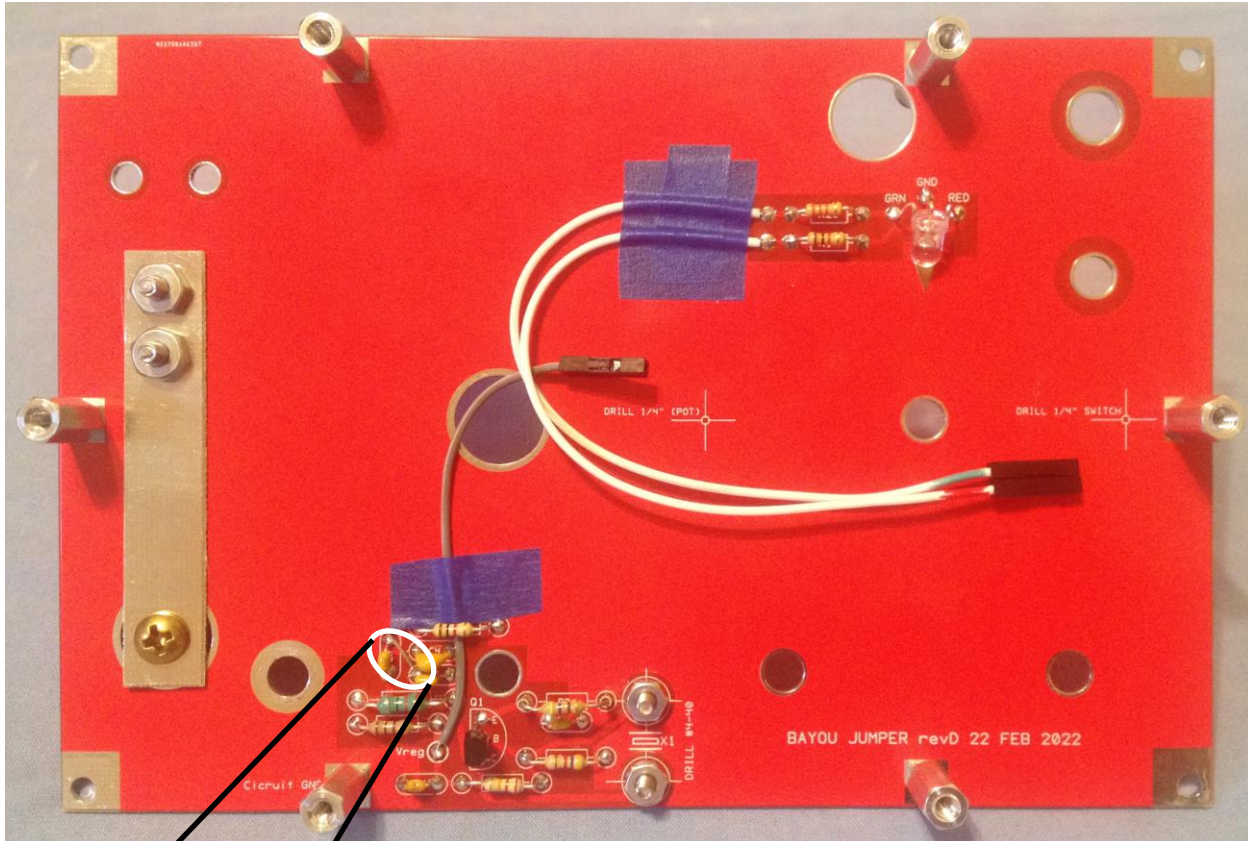

Notice the two #4-40 machine screws with nuts at **X1**, whose Phillips heads form the crystal contacts on the top side of the panel – between the REGEN and ATTEN controls.

There is a missing ground trace that must be remedied by running a jumper wire from the left-hand pad of **C2** to a nearby grounded pad at the top of **C3**. A discarded resistor lead may be used. This is a ground connection, so it is OK if the bare wire touches the surface of the PC board, just as long as it is clear of the left hand pad of **C4**

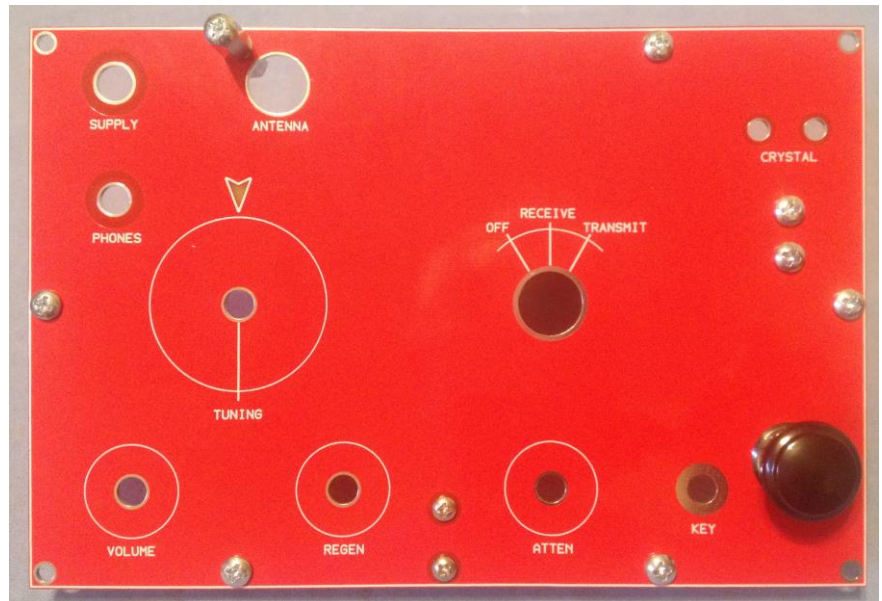

Design Notes

- Tuning range approximately 140 to 160 kHz – enough to cover the Extra Class CW band through the old “Novice Band.”
- One knob tuning – no bandset/bandspread needed.
- Only one toroid to wind in the receiver section. Etched PCB inductors used in the transmitter section.
- Varactor tuning employing readily available Schottky diodes as varactor diodes. Regeneration control also employs a “Schottky varactor” as the throttle capacitor.
- Use of potentiometers controlling only the DC bias on the varactors for tuning and regeneration means the controls are not “hot” with RF, so “hand effect” detuning is minimized.
- RF attenuator control, which is useful when employed with full-scale antennas.
- Robust headphone audio, and will drive a small speaker with modest volume.
- Current drain on receive about 20 to 25 mA, less than 600 mA on transmit at 5 W
- Harmonics and spurious down about 50 dB with respect to the fundamental, exceeding the FCC 43 dBc requirement.

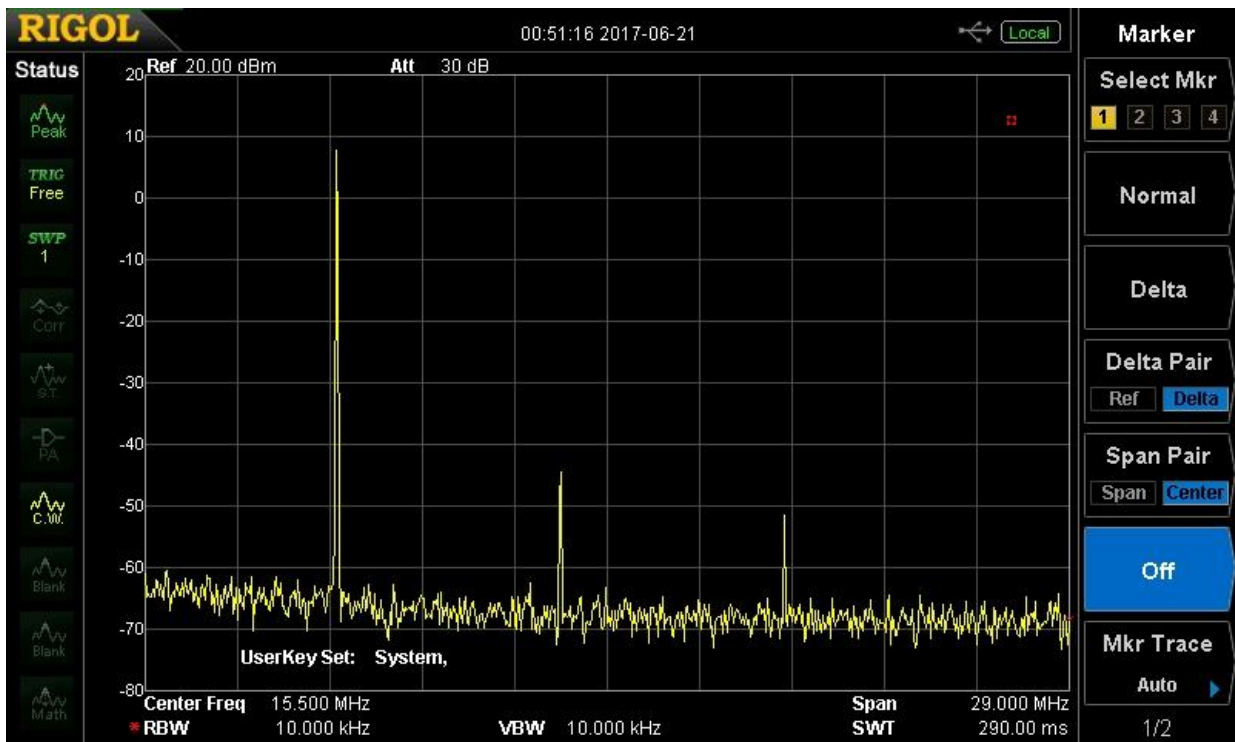

Bayou Jumper rev D (Red Panel) Bill of Materials (30 March 2022)

Inv√	Quant	Part ID(s)	Description	Marking	Notes
			CAPACITORS		
	1	C31	22 pF NP0 ceramic, 0.1" LS	22J , 22, or 220	Optional do not install yet
	2	C21,C30	4-20 pF trimmer capacitor	pink body	Note orientation of flat side
	3	C4, C18, C26	100 pf NP0 ceramic, 0.1" LS	101, tan body	
	1	C20	120 pF NP0 ceramic, 0.2" LS	121, blue body	
	1	C16	220 pF NP0 ceramic, 0.2" LS	221, blue body	
	1	C23	390 pF NP0 ceramic, 0.2" LS	391, blue body	
	1	C22	470 pF NP0 ceramic, 0.2" LS	471, tan body	
	3	C8, C14, C15	0.001 μF 200V NP0 ceramic, 0.2" LS	102, tan body	
	1	C28	0.0033 μF NP0 ceramic, 0.2" LS	332, tan body	
	4	C1,C2,C11,C17	0.01 μF ceramic, 0.1" LS	103, tan body	
	1	C24	0.033 μF ceramic, 0.2" LS	333, tan body	
	8	C5,C7,C19,C25 C27,C29,C32,C34	0.1 μF ceramic, 0.1" LS	104, tan body	
	1	C10	1 μF 50V electrolytic, 0.1" LS	1 μF, black	Note polarity
	4	C3,C6,C9,C13,	4.7 μF 16V electrolytic, 0.1" LS	4.7 μF, blue	Note polarity
	1	C12	47 μF 16V electrolytic, 0.1" LS	47 μF, black	Note polarity
			DIODES		
	3	D1, D2, D3	1N5819 Schottky diode	1N5819	Note polarity
	1	D4	Red/Green bi-color LED, 5 mm, common cathode, water clear lens		Note polarity, installed under top panel
	1	D5	1N914 Silicon small signal diode	1N914	Note polarity
			CONNECTORS		
	1	J1	BNC jack		Antenna
	1	J2	2.1x5.5 mm coaxial power jack		Power input
	1		2.1x5.5mm coaxial power plug		Mates with J2
	1	J3	1/8" mono jack, metal frame		Key
	1	J4	1/8" stereo jack, plastic housing		Phones
	2	J5, J6	Molex® female pins		Crystal socket
			INDUCTORS		
	1	L1	T68-7 iron powder toroid core	White body	
	1	L2	1.0 μH molded choke	Silver-Brown- Gold-Black-Silver	L2 is the physically larger choke
	1	L4	470 μH molded choke	Silver-Yellow- Violet-Brown- Silver	L4 is the physically smaller choke
			TRANSISTORS		
	2	Q1, Q3	2N3904 NPN BJT, TO-92	2N3904	
	1	Q2	J-310 JFET, TO-92	J-310	
	2	Q4, Q6	IRF510 MOSFET, TO-220	IRF510	Static sensitive
	1	Q5	2N7000 MOSFET, TO-92	2N7000	Static sensitive
	1	Q7	IRF-9640 MOSFET, TO-220	IRF-9640	Static sensitive, PC board is marked "IRF9Z24"

RESISTORS				
1	R16	100 Ω 1/4W 5% resistor	BRN-BLK-BRN	
2	R17, R19	1.0 K 1/4W 5% resistor	BRN-BLK-RED	R19 is installed under the top panel
1	R20	2.2 K 1/4W 5% resistor	RED-RED-RED	R20 is installed under the top panel
1	R3	2.7 K 1/4W 5% resistor	RED-VIO-RED	
2	R7, R12	3.3 K 1/4W 5% resistor	ORG-ORG-RED	
1	R5	33 K 1/4W 5% resistor	ORG-ORG-ORG	
1	R15	100 K 1/4W 5% resistor	BRN-BLK-YEL	
1	R13	330 K 1/4W 5% resistor	ORG-ORG-YEL	
4	R9,R11,R14,R18	470 K 1/4W 5% resistor	YEL-VIO-YEL	
2	R2, R4	1.0 M 1/4W 5% resistor	BRN-BLK-GRN	
1	R21	4.7 K 1/4W 5% resistor	YEL-VIO-RED	
1	R22	10 K 1/4W 5% resistor	BRN-BLK-ORG	
POTENTIOMETERS				
1	R1	5.0 K potentiometer	B5 02	$50 \times 10^2 = 5,000$
3	R6, R8, R10	50 K potentiometer	B5 03	$50 \times 10^3 = 50,000$
SWITCH				
1	SW1	4-pole 3-position rotary switch		
INTEGRATED CIRCUITS				
1	U1	NJM2113 audio amp DIP-8	NJM2113	Use supplied socket
1	U2	78L06 voltage regulator TO-92	78L06	
CRYSTALS				
1	X1	7030 kHz quartz crystal HC-49	7030	
1	X2	7122 kHz quartz crystal HC-49	7122	
2		Crystal Adapter PC board	Cajun Crystals	
OTHER HARDWARE				
1		Top panel PC board	Rev C	red solder mask
1		Main PC board	Rev C	green solder mask
2		Nylon screw insulator/bushing		Use with J5 & J6
1		“chicken head” pointer knob, will require an Allen wrench, 1.5 mm		OFF-Rx-Tx switch
3		Small control knob		VOLUME, REGEN, ATTEN controls
1		Large dial knob		Main tuning
4		2” long x 3/8” square wood post		For box mounting
15		3/8” #6-32 machine screw		For standoffs
6		5/8” #6-32 F-F hex standoff		Board-to-board
1		1/2” #6-32 M-F hex standoff		For xtal test post
1		3/16” #6-32 machine screw		For xtal test post
1		3/8” #6-32 F-F hex standoff		For CW key
1		Key knob		For CW key
4		#6-32 hex nuts		For CW key
1		PCB ”leaf spring” lever		For CW key
4		#6 flat washers		For CW key
1		3/8” #8-32 BRASS screw		For CW key
4		#6-32 sheet metal screws		joins panel to box
1		#4-40 x 1/2” machine screw		For Q7 mounting

	1		#4-40 nut		For Q7 mounting
	6 ft		AWG #24 enameled magnet wire		For toroid L1
	9 in		AWG #22 tinned bus wire		For jacks and jumpers
	6 in		AWG #10 bare copper wire		For crystal pins
	3 in		Red and Black insulated wire		For power jack
	12 in		“Dupont” female-female jumper wire		LED connections
	5	TP1, V-reg, GRN/RxVcc, RED	Header pins, 1 conductor		1 spare supplied
	1		DIP socket 8 pin		Socket for U1
			Optional parts for modifications Parts identified with * are NOT Supplied with the kit		See manual appendices
	1	*R5a	TBD, could be potentiometer		
	1	*C33	TBD, approx. 560 pF		
	1	*Filter switch	SPST miniature toggle		For Soup’er Up’er
	1	*Fine Tuning	1K potentiometer Bourns series PV09, 25 mm shaft, center detent Bourns PTV09A-4225F-B102		For Soup’er Up’er Same physical size & type as R1
	1	*C20a	10 pF NP0 ceramic, 0.2” LS	10	if needed to move tuning range lower
	1	C35	0.22 µF ceramic	224	alternative C34 for softer keying option
			Components for the modification described in APPENDIX R:		
	1	R23	200 Ω 1/4W 5% carbon film	RED-RED-BRN	
	1	R24	10 K 1/4W 5% carbon film	BRN-BLK-ORG	
	1	D6	Zener diode 5.6V	1N4734	note polarity
			Components for the modification described in APPENDIX Q: To be installed on the underside of the top panel		
	3	C1, C3, C6	0.01 µF 50 V ceramic, 0.2” lead space	103	
	1	C2	150 pF 50 V NP0/COG ceramic 0.2” lead space	151	
	1	C4	200 Pf or 220 pF 50 V NP0/COG ceramic, 0.2” lead space	201 or 221	
	1	R1	4.7 K 1/4W 5% carbon film	YEL-VIOL-RED	
	1	R2	22 K 1/4W 5% carbon film	RED-RED-ORG	
	1	R3	2 K 1/4W 5% carbon film	RED-BLK-RED	
	1	R4	100 Ω 1/4W 5% carbon film	BRN-BLK-BRN	
	1	R5	1 K 1/4W 5% carbon film	BRN-BLK-RED	
	1	Q1	2N3904 NPN BJT, TO-92	2N3904	
	1	L1	22 µH molded choke	RED-RED-BLK	
	1	Wire Jumper	4” long, with header socket at one end		
	2	# 4-40 x 1/2” Phillips head machine screw			
	2	# 4-40 nut			

APPENDICES

A. Rotary Switch Options

In case the indexing key washer should slip out of place while working with the switch, the photo at right shows the correct position of the washer's indexing tab relative to the index post on the body of the switch.

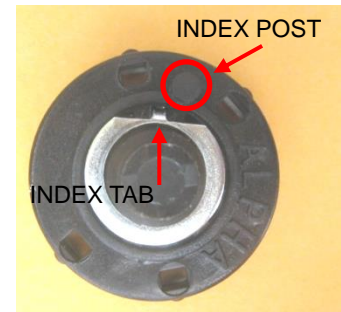

The shaft of the stock switch is a little too long to allow the selector knob to sit down close to the panel. It will not interfere with closing the lid of the recommended box, but if the appearance is not to your liking you can shorten the shaft. **Be sure to leave at least 1/4" of shaft remaining.** The best procedure is to hold or clamp the end of the shaft (so as to not apply stress to the switch body, and use a jeweler's saw, fine hacksaw, coping saw, or a band or scroll saw. Alternatively a cutoff disk in a Dremel tool could be used. It is even possible to use diagonal cutters, but don't try to make one clean cut through the shaft, best to nibble away until the desired length is attained.

B. Key Stiffness

The spring lever of the built-in key is made of thin double-sided PCB stock. If the touch feels too light, a replacement lever can be fashioned from thicker (1/16") stock.

Alternatively, the stock lever can be retained, but a "helper spring" made from 1/16" PCB stock can be installed as shown in the photo. The length of the helper plate will determine how much stiffness is added.

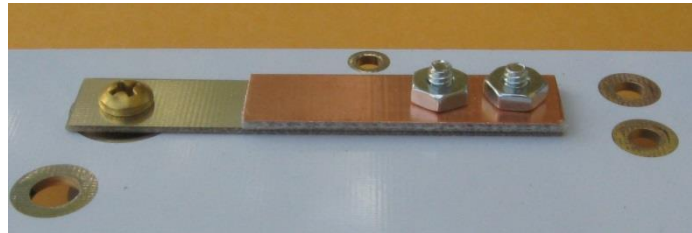

C. Main Tuning Knob

The metal skirt around the base of the tuning knob may have some rough edges that could scratch the finish of the panel. Use a piece of emery paper on a flat hard surface to sand the edge until it is flush with the plastic undersurface of the knob. A washer made of felt might be fashioned to slip between the knob and the panel, to prevent scratching and to provide some extra friction for the dial action.

D. Routing wires to the main PCB for installations of mods or accessories.

Since there is room under the main PCB as installed in the recommended box, the possibility of adding accessories such as an audio filter, sidetone oscillator, keyer, *etc*, are certainly attractive. Several “wireways” – pre-drilled ¼” holes in the circuit board – have been provided to allow for passing wires from above and below the main board. The holes are isolated from the top and bottom ground planes.

E. Tuning Range

An easy way to change the tuning range is to change the value of R5. Smaller resistance will increase the range, while larger resistance will decrease it. The downside of increasing the range is that the tuning will become more non-linear – tuning faster at the lower end of the band. R5 should not be decreased below about 5 to 10 k or so.

A pair of pads, designated **R5a**, have been provided. They are shorted across with a thin trace on the bottom of the PCB that must be cut if **R5a** is to be used. Inserting extra resistance, or better still, a potentiometer, at **R5a** will move the bottom of the tuning range up in frequency, while leaving the upper end virtually unchanged. So if most of the use of the radio were going to be in the 7100 to 7125 kHz region, it could be spread out over nearly the full travel of the main tuning control. But the range could be easily restored to cover the lower part of the band.



A potentiometer at **R5a** does act rather like a fine tuning control, but its effect is greatest at the low end of the range, diminishing to no effect at all at the top end.

F. PCB footprints for optional additional components (not supplied in the kit)

Mounting pads and connection points have been provided for an additional potentiometer (of the same physical type as the others in the kit) and a miniature SPDT toggle switch. Adjacent to each are a set of pads that can be used to make wire connection to the parts.

Possible uses for the potentiometer could be a fine tuning control, a keyer speed control, a sidetone pitch or level control. Bourns 9 mm pots, series PTV09A, 25 mm shafts, will fit the footprint. The **Soup'er Up'er** accessory uses these connection points (**Appendix I**)

The SPDT switch could switch an audio filter in or out, or select resistors at R5a to change the tuning range. Marlin P Jones # 25010SW (ON-OFF-ON), or similar, fits the footprint.

On the underside of the top panel are centering marks to allow drilling a hole properly positioned for these optional parts.

A pair of pads are provided for an optional capacitor, **C33**, to be installed across the feedback resistor of the audio amplifier IC. A few hundred pF has been found to “mellow” the audio sound of the receiver. The larger the capacitance the more the highs are suppressed.

G. Crystal Spotting

See **Appendix Q** for a new feature of the revD kits.

An outboard crystal spotting oscillator could be constructed. There is a description on the Bayou Jumper Yahoo Group of an example circuit. And Four State QRP Group offers a Crystal Spotter kit http://www.4sgrp.com/crystal_spotter.php

Another method is to disconnect the antenna and connect the crystal across the antenna terminals. When the receiver is tuned across the crystal resonant frequency a “pop” or “thump” is heard in the receiver. The method is quite precise and allows setting the receiver within a few hundred Hz of the true crystal frequency.

To simplify this process the BNC antenna connector has been relocated close to one of the PC board mounting standoffs. Installing the ½” standoff (topped with with a 3/16” 6-32 screw) on top of the top panel, replacing one of the 3/8” 6-32 screws, allows an FT-243 sized crystal to be easily connected momentarily between the center pin of the BNC jack and the grounded standoff.



There is an MP3 recording posted on the BayouJumper Yahoo group site that demonstrates the sound of the receiver tuning past the crystal frequency.

H. Alternate Style Crystal Adapters

These adapters allow for a series trimmer capacitor and/or a series inductor to be added. The crystal is installed in the same manner as the originals but, if either the capacitor or inductor were to be added, cut the associated trace(s). The solder mask has been removed above those traces for better visibility.



The series capacitor will raise the frequency, while the series inductor will lower it. If both are used a somewhat wider range of adjustment may be attained.

I. Connection points for potential modification or additions

There are nineteen extra pads on the PC board that connect to strategic points in the circuit. These points have been selected for installation of the **Soup'er Up'er** accessory, and because they may be useful for modifications or additions such as sidetone, audio filter, keyer, fine tuning, digital dial, etc.

Each point is identified on both the top and bottom silkscreens with a circle and an alphanumeric designator, as listed below. They are also identified on the schematics with the same designations.

A connects to the wiper of the main tuning potentiometer, R8
B connects to the cathode of the main tuning varactor diode, D3
TP1 connects to the Q2 end of the tickler winding for scope or counter

J7-1)
J7-3) these pads connect to the terminals of the optional potentiometer
J7-5)

J7-7 connects to the +12 V supply during both Tx and Rx operation
J7-9 connects to the +12 V supply during Rx operation only
J7-11 connects to the input resistor of the audio amplifier IC, U1
J7-13 connects to the internal key line
J7-15 connects to GND during Rx, is floating during Tx
J7-17 connects to the collector of the audio pre-amp transistor, Q3

J7-19)
J7-21) these pads connect to the terminals of the optional SPDT switch
J7-23)

J7-25 connects to the wiper of the volume control potentiometer, R6

ACCESSORY CONNECTIONS) These three pairs of pads can be used to connect to
) internally mounted accessories, such as a keyer. The left
) and center pairs are isolated. The right-hand pair is
) grounded

J. The NA1MH Soup'er Up'er Accessory

David Martin, NA1MH, designed an add-on for the Bayou Jumper that provides a sidetone, a fine tuning control, and the NMØS HI-PER-MITE audio filter. Look on the Four State QRP Group's kit page for information <http://www.4sgrp.com/souperuper.php>

A small PC board is attached to standoffs under one corner of the main board and is connected to the main board using the connection points described in **Appendix I**, above.

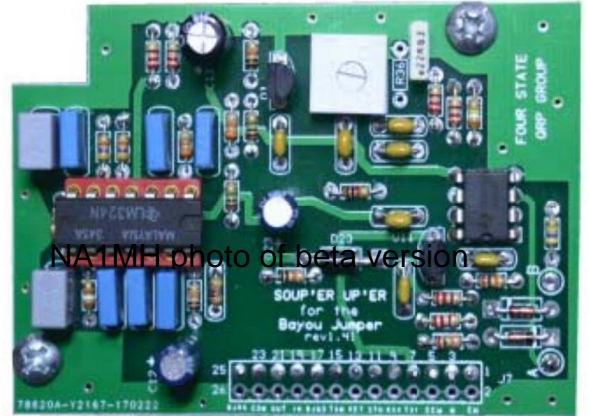

NA1MH photo of beta version

No trace cutting is required. However it is necessary to open the wire jumper JP-4 that was installed during the Bayou Jumper build (page 14). Just nip the loop of wire with cutters and slightly separate the cut ends. Also, R9 and C9 on the main Bayou Jumper PC board must be removed (see note on page 10).

Provisions for mounting a fine tuning potentiometer and filter IN/OUT switch have already been made on the revA circuit board (see **Appendix F**) and the underside of the top panel is marked to locate the holes to be drilled to accommodate the extra controls.



WØEB photo

K. Using a keyer

All revD kits employ P-channel MOSFET keying, so these mods are not needed. The revD Bayou Jumper will work with most any keyer, bug, cootie, or straight key. Info here is just FYI.

During transmit key-down intervals the keying current of the Bayou Jumper is about 750 mA, which will exceed the capability of many keyer output circuits. A robust PNP power transistor, a MOSFET power switch, or a relay, are called for.

In the special case of the Four State QRP Group's **EZ-Keyer**, the supplied BS170 output transistor could be replaced with a heftier MOSFET such as the IRF510.

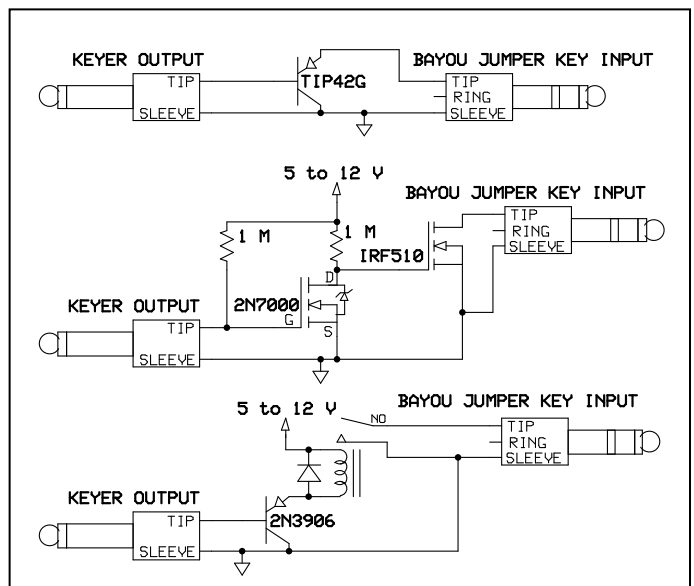

Any one of the circuits above, suggested by NMØS, could be used to interface between a conventional keyer and the earlier versions of the Bayou Jumper.

L. Connecting external audio devices (amplifier, filter, etc)

The Bayou Jumper's audio amplifier device (NJM2113) employs a differential output stage which is not referenced to the circuit ground. That is why only the tip and ring contacts of the stereo jack are connected, and the sleeve is left floating. This type circuit does not require the large series capacitor such as used with LM386 amplifiers, and as a result, the low frequency response of the audio stage is improved.

But since both outputs of the IC are internally biased at approximately half the supply voltage, connecting either output pin to circuit ground will produce a short circuit which will irretrievably damage the chip.

If you want to use an external amplifier, or external narrow band audio filter (such as a NEscaf or HI-PER-MITE) you must use a DC blocking capacitor in series with both the tip and ring connections. Check the schematic of your external device. A blocking capacitor may already be in place in the signal lead, so you would only need to add one in the common lead.

Since most of these devices have a relatively high input impedance, the capacitance does not need to be very large – you may be able to use a common 0.1 μF capacitor. If an electrolytic capacitor is used, the positive side should be connected to the tip and/or ring of the headphone jack.

The diagram below illustrates a proper connection to a HI-PER-MITE audio filter (top) or other generic active audio device (bottom).

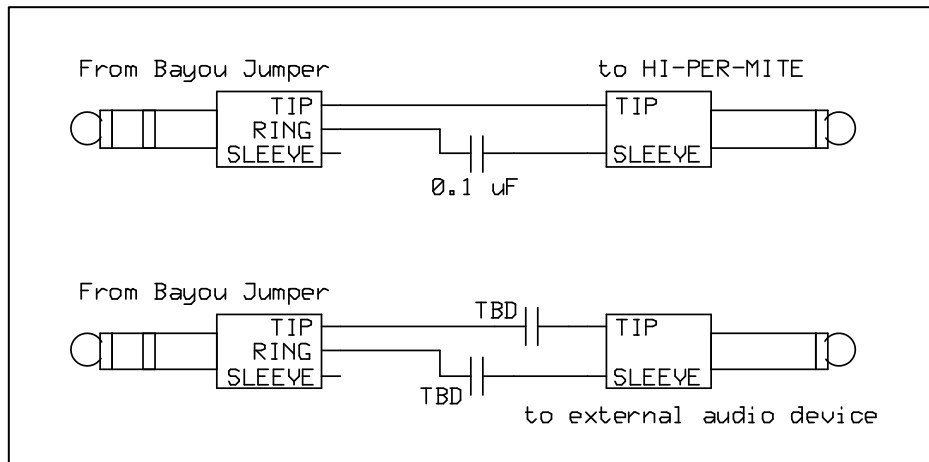

M. Measured values from a rev B, beta build Bayou Jumper

Tuning range:

Very tight 19 turn main winding

With C30 at maximum capacitance, initial range was 6813 – 6959 kHz

Adjusting C30, only, yielded the result below

Dial setting	Rx zero beat frequency, kHz
0	7002.0
1	7004.3
2	7030.1
3	7063.3
4	7087.7
5	7107.8
6	7125.6
7	7142.6
8	7159.3
9	7162.0

Receive mode current draw (12.4 volt supply) with normal headphone volume:
24 mA

Transmit mode, idling current (12.4 V supply):
key up: 17 mA

Transmit power measurements:

Voltages measured at the power jack, key down, 7120.1 kHz (7122 crystal)

V _{supply} at power jack	RF output Peak-peak volts	RF output watts	Supply current mA	PA efficiency
11.0	35.2	3.1	360	78%
12.0	38.4	3.7	395	78%
13.0	41.6	4.3	425	78%
14.0	44.0	4.8	455	81%
Fully charged 12 V, 7 A-hr AGM battery	40.8	4.2		
3 x 18650 lithium-ion cells, fully charged	38.4	3.7		

Harmonic suppression measured with a Rigol spectrum analyzer:
All harmonics at least 50 dB below the fundamental

N. Critical Dimensions of PC Board and Enclosure

With some folks having trouble laying hands on the recommended Hobby Lobby box:

<http://www.hobbylobby.com/Crafts-Hobbies/Wood-Crafting/Unfinished-Wood/Wood-Rectangle-Box-Set-with-Silver-Handle/p/25426-GA0369>

The on-line sale is for a set of three boxes, of which the smallest is used.

The boxes can be purchased individually in stores, **SKU# 662536S**.

here are some dimensions which might help in a roll-your-own.

First the PC Boards:

They were designed on a decimal inches grid. The primary dimensions in those units, as specified to the manufacturer was:

7.186" long x 4.800" wide (182.525 mm x 121.920 mm)

actual measurements here, on a sample of two, agree within ability to measure (< 0.5 mm)

The top panel is a complete rectangle of those dimensions

The main PCB has 0.425" x 0.425" (10.795 mm x 10.795 mm) cutouts at the four corners

The PC boards are 1.6mm (0.063") thick

The four mounting holes at the corners of the top panel are 0.15" (3.81 mm) in diameter, and their centers lie on the vertices of a 6.925" x 4.550" (175.895 x 115.570 mm) rectangle

The Hobby Lobby "small box" dimensions, in mm:

(inside dimensions) 183 mm side to side, 123 mm front to back, and 52 mm deep.

cover is the same length and width, except the depth is 21 mm

the thickness of the wood sides is about 8 mm, and the top and bottom are about 2 mm thick.

To fit the completed kit into a box there must be a clearance, measured from the bottom surface of the top panel to the inside bottom of the box, of 28 mm (1.1"), and 20 mm (0.8") from the top surface of the top panel to the inside surface of the top of the box.

P. Rotating R8 to use the Alternate Tuning Index Mark

If you decide to rotate R8 so that the knob's numbered scale will align with the alternate index mark at the bottom of the dial, you'll need to install three wire jumpers as shown by the red, blue, and yellow lines in the drawing at right. Install these jumpers on the bottom side of the PC board using the slightly smaller set of three pads, along with the unused set of "normal" R8 mounting pads. Do this only after R8 has been completely soldered in place, having used the larger set of three pads (red arrows) on the top of the board just above the "TUNING" label for R8's pins.

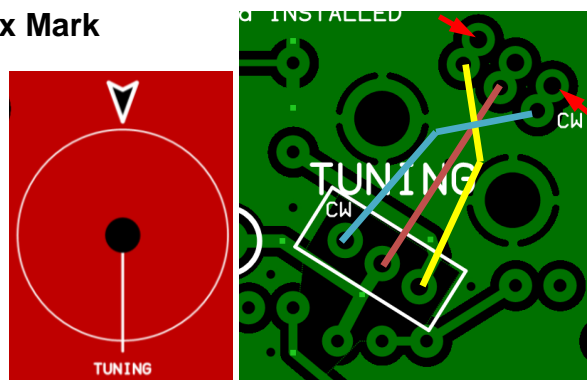

Q. Built-in Crystal Spotter Mod

This revD Bayou Jumper kit includes provisions (*lagniappe*, as we say in Louisiana) to add the *NSIB Crystal Spotter* right in the rig! On the underside of the top panel board there's a layout for a crystal spotter to be built "Pittsburg-style" just like the Four State QRP Crystal Spotter kit. Refer to instructions for the 4SQR kit: http://www.4sqr.com/crystal_spotter.php

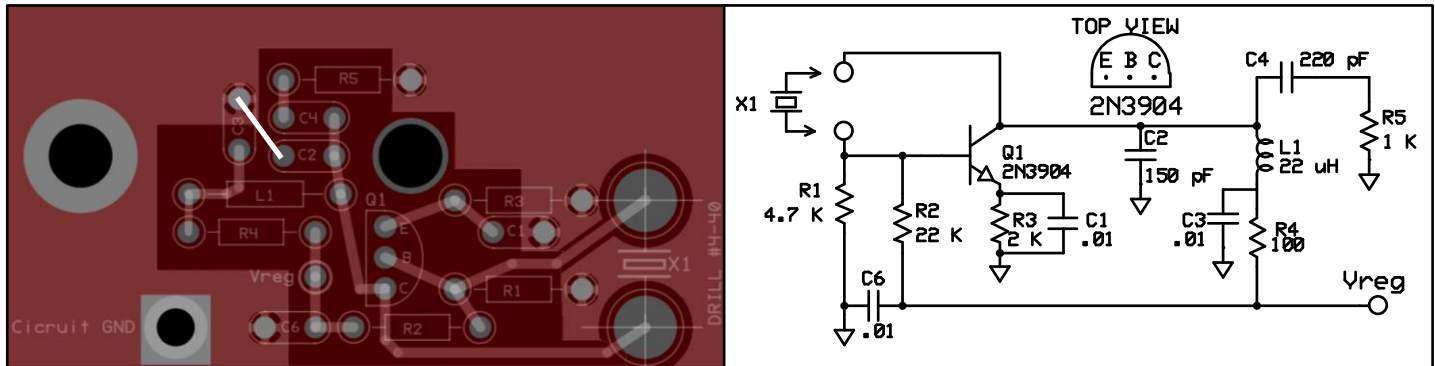

There is a PC board error that must be fixed. Run a jumper (white line in the picture) from the left pad of C2 to the top pad of C3. You can use a bare wire from a discarded resistor lead, since this is a grounded connection. See also the photos on page 38.

The values of R2 and R3 are changed from the original Spotter kit's bill of materials. A smaller R2 (22 K) to allow the circuit to operate from the 6 V regulated supply in the Bayou Jumper, and a larger R3 (2 K) to reduce the level of signal so as to not overload the Bayou Jumper's regen receiver too badly. And the original Spotter's power switch and battery are omitted, as this circuit draws only about a mA from Vreg unless a crystal is connected.

Two holes must be drilled in the top panel to accept a pair of #4-40 x 1/2" machine screws, whose Phillips heads form the contacts for the crystal on the top panel. The drilling locations are marked on the PC board silkscreen. Extend printed the center lines across the large tinned pads. Pilot drill or center punch them and then drill with a #32 drill (1/8" will serve if you don't have a #32). Secure the screws with #4-40 nuts (and lockwashers if you wish)

Power for the circuit is obtained by a jumper wire from the "Vreg" pad on the spotter to the "Vreg" test pin on the main Bayou Jumper board. A plug-in header socket at the main board (in the manner of the LED connections) will allow for easy connect/disconnect. The ground connection is made through the standoff posts that join the main and top panel boards, so the two boards must be mated for the spotter to function.

To use the spotter, be in Rx mode, turn the REGEN control fully clockwise, and reduce the VOLUME (it'll be loud!). Touch the crystal pins to the screw-head contacts and tune for the signal. Because it is a very strong signal in close proximity to the detector, there will be a bit of a dead band at the center of the zero beat tuning, but it will be quite close enough to know where your crystal falls on the dial. You'll probably discover that the transmitter output will actually be a kHz or so below the spotted frequency, so compensate by setting the tuning on the low side of zero beat.

Spotter BOM: Q1: 2N3904, R1: 4.7K (yel-vio-red), R2: 22 K (red-red-org), R3: 2 K (red-brn-red), R4: 100Ω (brn-blk-brn), R5: 1K (brn-blk-red), C1 C3 C6: 0.01μF (103), C4: 220 pF (221), C2: 150pF (151), L1: 22 μH (red-red-blk), 2 each #4-40 x 1/2" Phillips-head machine screws with nuts

This modification has some serious ramifications that you will want to ponder before deciding to proceed. It involves re-routing the 12 V power supply path. Jumpers have been provided on the circuit board to effect the change without having to cut any traces or remove components... but...

The end result will be that the radio is always powered up whenever it is connected to a battery or live power supply – regardless of the position of the OFF-Rx-Tx switch. A few mA of current will be drawn at all times, which **will** drain a battery if left in that condition for an extended time. As the Romans would say - *caveat aedificator* – builders beware.

The good news is (a) the LED will illuminate to warn you the rig is powered (b) the rig won't transmit unless the mode switch is in TRANSMIT (c) the antenna is disconnected if the mode switch is OFF, and (d) it is very easy to undo the mod if you don't like the result.

Step 1. Bypass the power switch SW1a and bring the 12 V supply directly to the Rx and Tx circuits. To accomplish this:

- Install the jumper **JP8** (located below L6, to the right of D1)

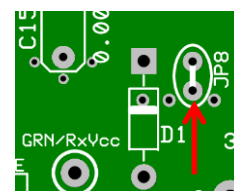

With the receiver circuits now powered up all the time, even during transmit, there would be an unholy howl in the headphones every time you pressed the key. The now active receiver needs to be muted during transmit. Fortunately the audio amplifier U1 (NJM2113) has a provision to do this.

Pin 1 of U1 is the “not enable” pin, meaning when that pin is grounded (i.e., not true) the amplifier is active. If that pin is pulled up to the supply voltage the amplifier will be disabled. Pin 1 is normally grounded at all times via jumper **JP6**. It is necessary to lift that ground connection and install a pull-up resistor to the 12 V bus. Then the pin will be connected to SW1c pin 8, which will provide the necessary ground connection during receive.

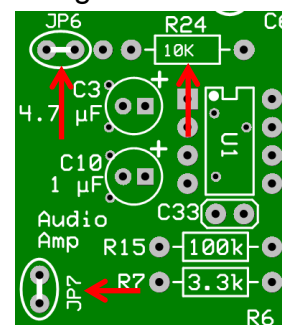

Step 2. Lift the ground connection from U-1 pin 1 and pull it up to the 12 V supply bus. Then connect pin 1 to SW1c-8. To accomplish this:

- Cut the jumper **JP6** (near U1) you need only cut the jumper at the top of the loop and separate the cut ends slightly
- Install the pull-up resistor **R24** (near JP6), 10 K BRN-BLK-ORG
- Install the jumper **JP7** (below the “Audio Amp” label)

That's it. Try it out.

If you wish you could, rather than putting a wire jumper at JP8, connect those jumper pads to a SPST switch on the top panel as a “master” ON/OFF. You'd have to select a spot and drill a hole.

If you decide you don't like the way the rig operates after the mod, just:

- cut JP8
- cut JP7
- restore JP6 (squeeze the cut ends together and solder)
- you do not have to remove R24

